



Instructions for Econo Plus Feeder Kit

THANK YOU for your purchase of the Econo Plus Feeder Kit. Please read this sheet before operating the unit. If you should have any questions about this product or any other Moultrie product, please contact us using the information below. To help us to better serve you, please complete and mail the enclosed Warranty Card.

I DRILLING YOUR DRUM/BARREL/BUCKET

NOTE: If you purchased a Moultrie Drum, go to II

Econo Plus Feeder will mount to the bottom of any drum or bucket

CAUTION: WEAR EYE PROTECTION

- 1** Turn drum over, measure and mark the center of the bottom.
- 2** Center the template on the bottom of the drum and secure with tape. Drill two 3/16" Funnel holes and three 5/16" Feeder Leg holes.
- 3** Using a Hole Saw, drill a 2-1/4" hole in the center of the bottom of your drum.

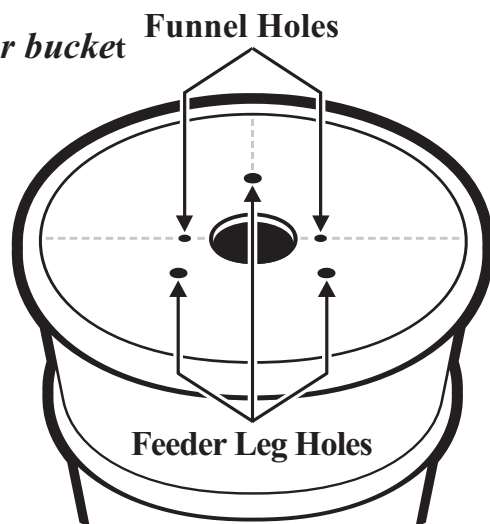

II MOUNTING THE FEEDER

- 1** Place **Funnel** *inside* **Drum** with small end of funnel facing down, and attach with two **Short Bolts** using nuts and washers provided.

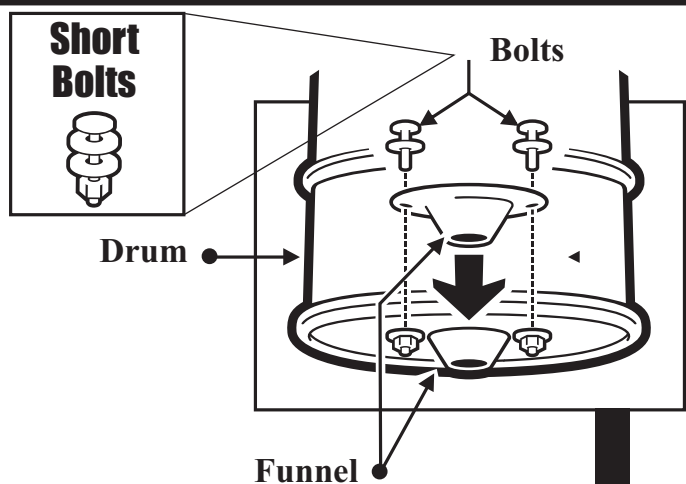

- 2** Turn **Drum** upside down.

Turn upside down

- 3** Place **Feeder** on **Drum**. Attach **Feeder Legs** to **Drum** as shown with **Long Bolts** using nuts and washers provided.

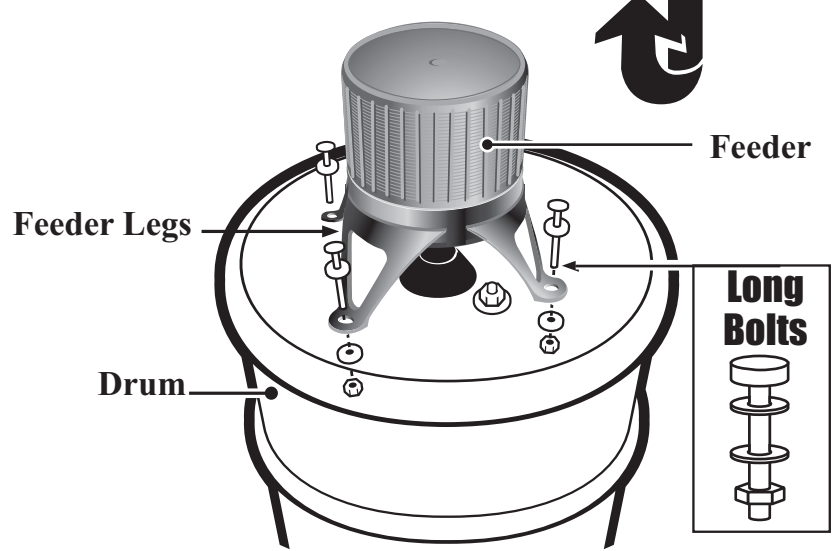

NOTE: This equipment has been tested and found to comply with the limits for a Class B digital device pursuant to Part 15 of the FCC rules. These limits are designed to provide reasonable protection against harmful interference in a residential installation. This equipment generates, uses and can radiate radio frequency energy and, if not installed and used in accordance with the instructions, may cause harmful interference to radio communications. However, there is no guarantee that interference will not occur in a particular installation. If this equipment does cause harmful interference to radio or television reception, which can be determined by turning the equipment off and on, the user is encouraged to correct the interference by one or more of the following measures:

- Reorient or relocate the receiving antenna
- Increase the separation between the equipment and the receiver

III INSTALLING BATTERY

CAUTION: WEAR EYE PROTECTION

Remove bottom and install a 6-Volt Alkaline (ex. Energizer™) or Moultrie rechargeable battery by attaching the Red Alligator Clip to the positive terminal (+) and the Black Alligator Clip to the negative (-) terminal. Place bottom on unit and secure using wing nut. Unit is now ready for operation.

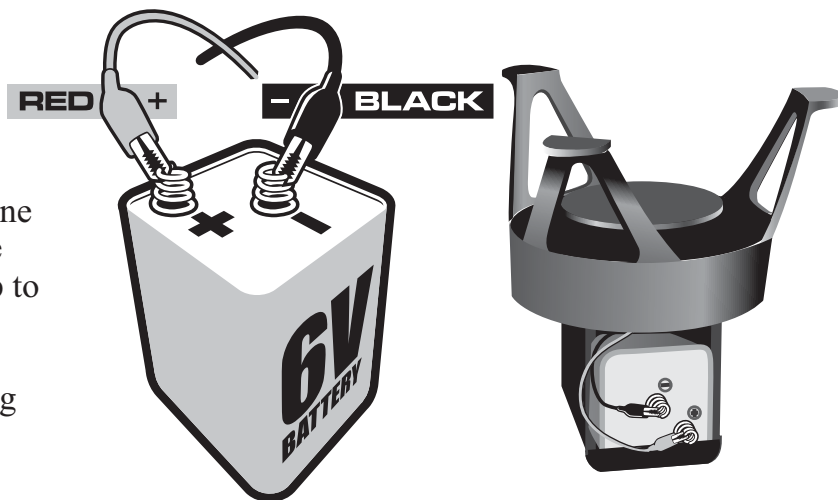

IV SETTING TIME OF DAY

To set the current time, press the UP or DN buttons on the right side of the Timer. Hold button down to advance quickly. Press button repeatedly to select a specific minute. The lights on left side of the display indicate AM or PM.

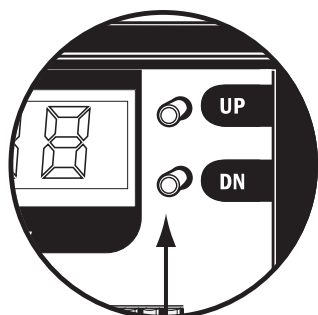

Time Set buttons

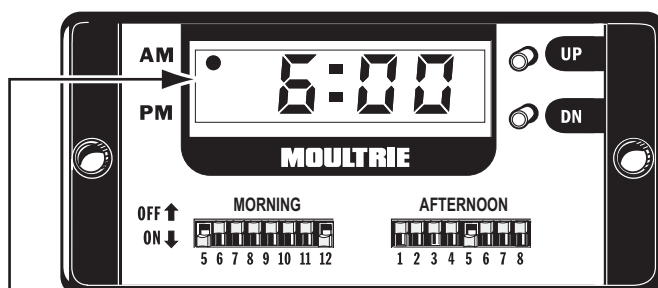

AM / PM Indicator lights



Your Pro Econo is equipped with a power saving feature which turns off the display after 15 seconds of inactivity. The display does not need to be on in order for the feeder to operate. Press the UP or DN button to turn the display back on.

V SETTING FEED TIMES, RUN TIME AND TEST FEEDER

FEED TIMES: The Pro Econo allows you to feed up to 16 times per day between the hours of 5:00am and 8:00pm. To select the times to feed, slide the switch to the “ON” position that corresponds to the hour(s) desired.

The illustration on the right indicates that the Timer will feed at 5:00 am, 12:00 pm (noon), and 5:00 pm



RUN TIME: The motor Run Time adjustment allows you to adjust the amount of feed dispensed. To adjust Run Time, press and release the UP and DN buttons simultaneously. Once displayed, the Run Time may be adjusted by pressing the UP or DN buttons.

RUN TIME (sec.)	2	4	6	8	10	12	14	16	18	20
Approx. feed dispensed (lbs.)	.25	.75	1	1.5	2	2.5	3	3.5	4	4.5

FEEDER TEST: To test the motor, press and hold UP and DN buttons simultaneously until a “5” appears on the left hand side of the display. You now have 5 seconds to get away from the feeder before the motor runs for the RUN TIME selected.

TIPS & POINTERS

1: (Q) What battery should I use? (A) For best performance, use a rechargeable 6-Volt, 5 Amp-Hour Moultrie brand battery. If disposable batteries will be used, Energizer™ Alkaline batteries are recommended.

2: (Q) What should I do if the timer isn't working? (A) Check the connections to the battery to make sure alligator clips have not come loose. Then check the battery itself by changing to a known good battery. If the problem still persists, call Moultrie Customer Service at the number below.



Our Service Department will gladly answer any questions you have.
 Call 205-664-6700 Monday – Friday, 8:00 AM to 5:00 PM CST.
www.moultriefeeders.com



Instructions for 30 Gallon Hanging Feeder

THANK YOU for your purchase of the **Hanging Feeder**, a top quality Moultrie product. Please read this sheet before operating this unit. If you should have any questions about this or any other Moultrie product, please contact us using the information at bottom of page.

To help us better serve you, please complete and mail the enclosed Warranty Card.

I MOUNT YOUR FEEDER KIT TO DRUM

Using instructions provided with your Feeder Kit, mount your feeder and small funnel to the bottom of the Drum.

II INSTALL OPTIONAL LARGE FUNNEL

If you will be using an optional 30 gallon internal funnel (#MFH-FUN30), install per the instructions provided with funnel.

III INSTALL HANGING BRACKET

Insert steel rod with **Coupler Nuts** in **Drum**. With **Nuts** and **Washers** on outside of drum, Tighten eye bolts into **Coupler Nuts**.

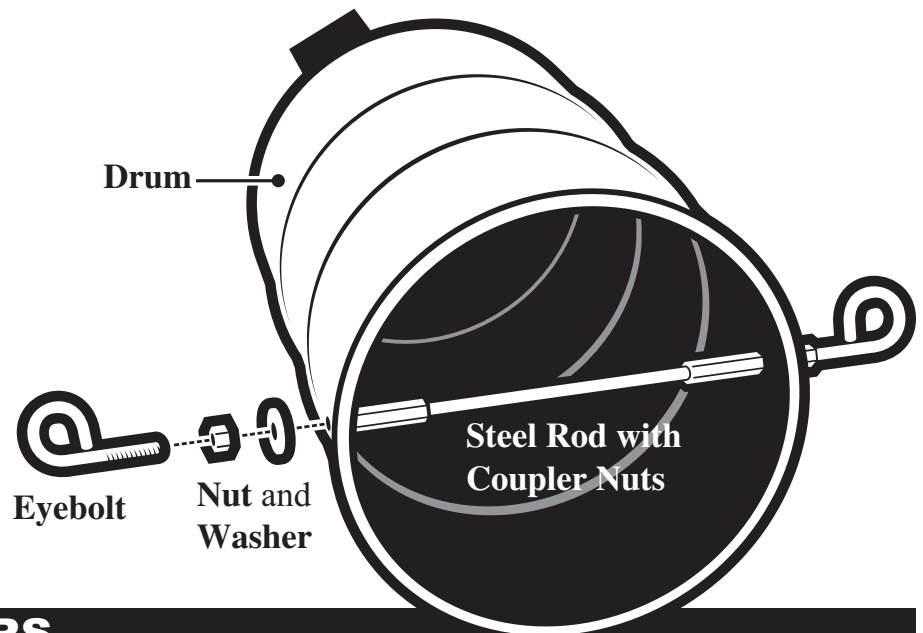

IV TIPS AND POINTERS

1: (Q) When should I fill the drum on my feeder? (A) To prevent damage to the feeder, do not load drum until unit is off the ground.

2: (Q) This is going to be heavy. How should I hang it? (A) A 30 gallon drum can hold up to 200 lbs. of feed; we suggest using block and tackle to raise to desired height, then secure as required.

3: (Q) What should I hang it with and how high should I hang it? (A) Some animals will chew through products like rope, so chain or steel cable is best. The bottom of the feeder should be about 7 feet from the ground.



Our Service Department will gladly answer any questions you have.
Call 205-664-6700 Monday – Friday, 8:00 AM to 5:00 PM CST.
www.moultriefeeders.com