



**SUMMIT**  
EST. 1981  
**TREESTANDS**

# Trophy Chair

## Instruction Booklet - 2007

You **MUST** also view the enclosed DVD **BEFORE** using your new treestand!!  
Weight Limit 260 lbs. total. **DO NOT EXCEED THIS LIMIT!**  
Tree Size: 8" - 30" Diameter

---

### READ ME FIRST!!!

Please read carefully **BEFORE** using your new Summit Trophy Chair.

Congratulations! You have purchased the finest commercially available tree seat on the market today. Summit's Trophy Chair is designed and built to provide years of trouble-free, successful hunting with a minimum of maintenance and care. It is certified to meet the requirements of the Treestand Manufacturers Association (TMA) Standards. This booklet is provided to you to outline the recommended use, care and maintenance of your Summit Trophy Chair.

### Warnings and Precautions

- **ANYTIME THIS TREE SEAT IS USED IN CONJUNCTION WITH A PLATFORM SUCH AS THE BASIC SYSTEM, IT IS MANDATORY THAT A FULL BODY SAFETY HARNESS BE USED!!**
- **IT IS IMPORTANT TO NOTE THAT A TREESTAND FALL CAN OCCUR AT ANY TIME AFTER LEAVING THE GROUND!**
- **YOU MUST FULLY READ, UNDERSTAND AND FOLLOW THESE INSTRUCTIONS! PLEASE CONTACT SUMMIT TREESTANDS IF YOU HAVE ANY QUESTIONS ON THE USE OF THIS PRODUCT! FAILURE TO FOLLOW THESE INSTRUCTIONS MAY CAUSE SERIOUS INJURY OR DEATH!!**
- **BEFORE USING ANY TREESTAND, BE SURE YOU MAINTAIN FULL BODY SAFETY HARNESS ATTACHMENT TO THE TREE AT ALL TIMES AFTER LEAVING THE GROUND!!! YOU MUST STAY CONNECTED TO YOUR FALL ARREST SYSTEM AT ALL TIMES AFTER LEAVING THE GROUND!**
- **DO NOT USE THIS OR ANY OTHER TREESTAND IF YOU HAVE BEEN USING DRUGS (EVEN PRESCRIPTION) OR ALCOHOL OR ARE PHYSICALLY IMPAIRED IN ANY WAY! NEVER USE A TREESTAND WHEN FEELING ILL, NAUSEOUS OR DIZZY!**
- **FOR YOUR SAFETY, DO NOT USE ANY TREESTAND DURING RAIN, LIGHTNING, WINDSTORMS, WHEN TREES ARE WET OR ICY, OR ON TREES THAT ARE LEANING, TREES THAT APPEAR DEAD OR DISEASED OR ON UTILITY POLES!!! NEVER RELY ON A TREE BRANCH FOR SUPPORT!**
- **DO NOT USE ANY TREESTAND IF YOU HAVE NOT FOLLOWED THE MANUFACTURERS CARE AND MAINTENANCE GUIDELINES! NEVER MODIFY YOUR STAND BY MAKING REPAIRS, REPLACING PARTS, ALTERING PARTS OR ATTACHING ANYTHING TO IT UNLESS EXPLICITLY AUTHORIZED BY SUMMIT TREESTANDS!**
- **ALWAYS INSPECT THE STAND / CABLE SYSTEM OR HANGING STRAPS AND ANY SAFETY GEAR BEFORE EACH USE! IF ANY PROBLEMS ARE FOUND - DO NOT USE THE STAND! CONTACT CUSTOMER SERVICE FOR THE APPROPRIATE REPAIR / REPLACEMENT PROCEDURE!**
- **NEVER ALLOW THE SAFETY HARNESS TETHER TO GET UNDER OR AROUND YOUR NECK!**
- **IT IS IMPORTANT THAT YOU REMEMBER TO BE PREPARED IF YOU HAPPEN TO FALL AND EMPLOY YOUR SAFETY HARNESS WHILE IN A TREESTAND. STAY CALM AND DO NOT PANIC. YOU MUST BE PREPARED TO RECOVER FROM YOUR FALL BY EITHER CLIMBING BACK ONTO YOUR TREESTAND OR USING A DEVICE SUCH AS THE "TREE DESCENDER" (AVAILABLE FROM SUMMIT, WWW.SUMMITSTANDS.COM, 256-353-0634). PRIOR TO HUNTING: YOU MUST NOTIFY SOMEONE OF YOUR HUNTING LOCATION AND WHEN YOU WILL RETURN!**
- **DO NOT USE ANY TREESTAND UNLESS YOU ARE IN GOOD PHYSICAL SHAPE. THE ABILITY TO DO SEVERAL PUSH-UPS, CHIN-UPS, SIT-UPS, ETC. IS REQUIRED FOR YOUR SAFETY!**
- **ALWAYS USE A HAUL LINE TO RAISE AND LOWER UNLOADED FIREARMS AND BOWS! FIREARMS MUST BE PULLED UP UNLOADED, CHAMBER OPEN AND MUZZLE DOWN!**
- **NEVER CLIMB WITH ANYTHING IN YOUR HANDS OR ON YOUR BACK - USE A HAUL LINE!**
- **PRACTICE USING YOUR TREESTAND AND SAFETY HARNESS AT A LOW LEVEL (5 FEET) UNTIL YOU MASTER ITS USE!**
- **BE WELL RESTED AND NEVER GET IN A HURRY. HURRYING CAUSES ACCIDENTS!!**
- **INSTRUCTIONS (WRITTEN AND VIDEO) SHOULD BE REVIEWED AT LEAST ANNUALLY. IF YOU LOAN OR SELL THIS TREESTAND, IT IS YOUR RESPONSIBILITY TO FURNISH THE BUYER A COPY OF THESE INSTRUCTIONS AND THE VIDEO THAT CAME WITH THE TREESTAND. MAKE SURE THEY WATCH THE VIDEO AND READ / UNDERSTAND THE INSTRUCTIONS!**

---

### Warning

Before each use of your Summit Treestand, **ALWAYS** inspect the treestand for any structural damage, cracks, cable wear or abrasion that may have occurred in transporting your treestand. **DO NOT USE IF ANY DAMAGE IS FOUND! DO NOT** leave your treestand outdoors when it is not being used. **Any tubing that is allowed to fill with rainwater and freeze WILL rupture or burst. DO NOT use your treestand if this happens.**

## Section 1. Assembling your new Trophy Chair.

Please contact us at [www.summitstands.com](http://www.summitstands.com) or 256-353-0634 to obtain any missing parts or if your DVD does not work.

### Part 1. Trophy Chair Assembly

**Step 1.** Place two short shank bushings on the **outside** of the bracket on the Arm Support Assembly as shown in **Figure 1**.

**Step 2.** Place two short shank bushings on the **outside** of the middle bracket on the Seat Post as shown in **Figure 1**.

**Step 3.** Place two short shank bushings on the **outside** of the lower bracket on the Seat Post as shown in **Figure 1**.

**Step 4.** Position the Arm Support and Seat Post as shown in **Figure 2**. Secure with two 3/4" bolts and lock nuts. Wrench tighten.

**Step 5.** Position the Support rod as shown in **Figure 2**. Secure each side using one 3/4" bolt with lock nuts. **Do not overtighten as this connection is designed to pivot.** Seat Frame should slide and pivot. If it does not, slightly loosen bolt.

**Step 7.** Position seat then slide it down onto the Arm Support Bar as shown in **Figure 3**.

**Step 8.** Use two self tapping screws to secure the seat webbing to the Arm Support bar. Run the screws in from the side as shown in **Figure 4**. A powered screw driver works best for this step.

**Step 9.** Position the arm rest pads as shown in **Figure 5**. The cable ties for attaching the pads are "in-line" cable ties: Note the correct and incorrect ways of attaching. To attach - pull the cable ties snug, cut off the excess, and rotate the clasp to the underside of the pad. Use two cable ties per pad.

**Step 10.** Push the looped end of the cam buckle strap through the welded wire loop on the top of the Seat Post. Loop the strap and buckle back through the sewn loop to create a cinch knot as shown in **Figure 6**.

### Part 2. Carrying your Trophy Chair

To carry the Trophy Chair, first fold it flat. Next, take the supplied green tourniquet buckle strap and wrap it around the frame to secure it as shown in **Figure 7**. Take the long cam buckle tree strap and bring it over your shoulder. Clip the double J-Hook into the Support Rod slide to secure as shown in **Figure 8**.

## Section 2. Use of the Trophy Chair.

**Step 1.** Wrap the cam buckle strap around the tree and hook the double J-Hook into the seat frame as shown in **Figure 9**.

**Step 2.** Pull the free end of the strap until tight.

**Step 3.** Push down on the chair to seat it on the tree.

**Step 4.** Wrap the supplied green tourniquet buckle strap the frame and the tree to secure (See **Figure 10**).

**Step 5.** Secure the seat back to the tree by wrapping the bungee cord around the tree and clipping it to its self.

## Section 3. Maintenance and Care of Your Treestand.

Because of the quality construction techniques used in manufacturing, your Summit Treestand is very durable under normal hunting conditions. However, since all hunting equipment that is exposed to the elements requires some maintenance and care, the following guidelines for caring for your treestand should be used. **DO NOT** leave your treestand outdoors when it is not being used. **Any tubing that is allowed to fill with rainwater and freeze WILL rupture or burst.** **DO NOT** use your treestand if this happens. If your treestand is exposed to the elements, it will be necessary to cover the seat to prevent rain and moisture from saturating the material. This will extend the life of the seat material as well as make it more comfortable the next time it is used.

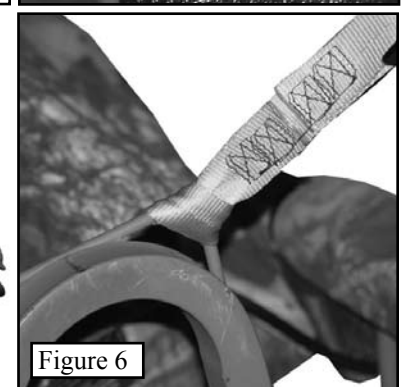
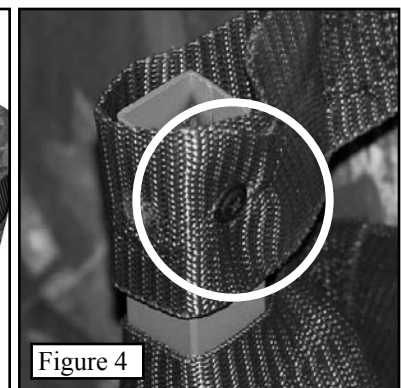
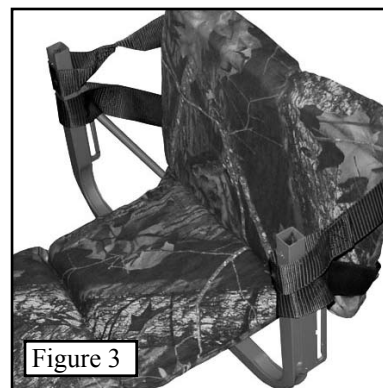
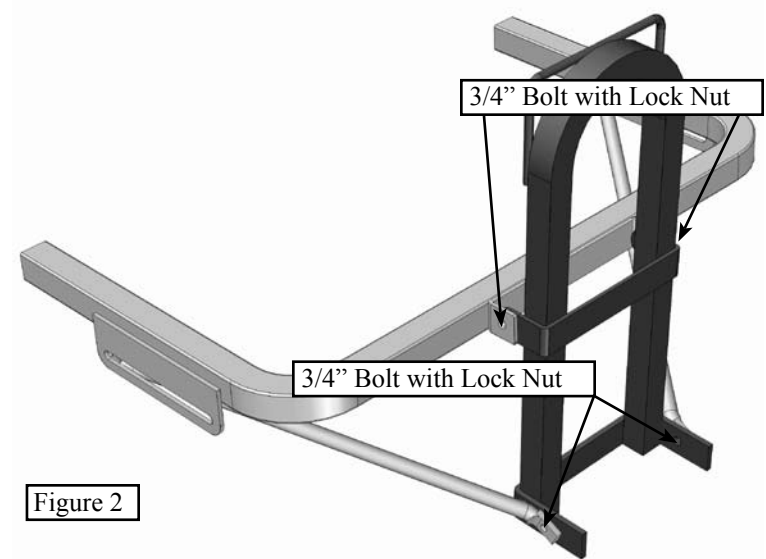
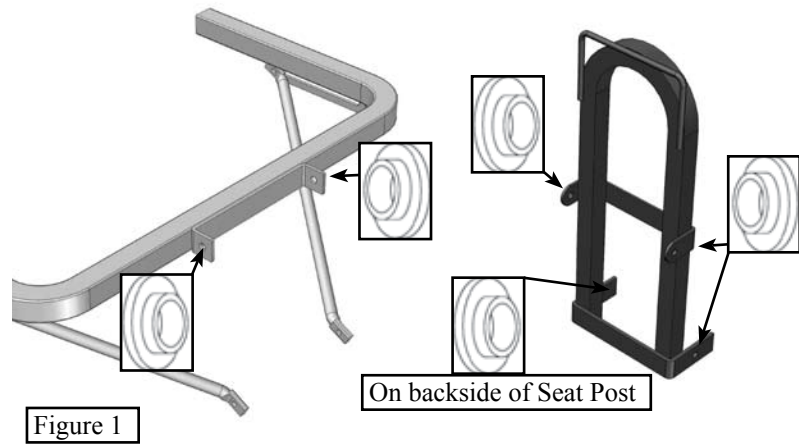

The powder coat finish that is applied at the factory is very durable and should need touch ups only in areas of heavy wear or accidental impact.

Should you damage any part of your Summit Treestand, contact your nearest authorized Summit dealer or the factory to obtain the proper corrective action procedure and/or replacement parts for the treestand. Unauthorized repairs, modifications, or alterations will void the warranty and could degrade the integrity of the treestand. You must perform periodic inspections of the treestand for damage.

**WARNING: DO NOT** use the treestand if **ANY** obvious or suspected damage is observed.

**CAUTION:** Look for nicks, gouges, cuts, cracks, bends, corrosion or similar damage that can be the result of improper use or accidental damage. For instance, this could occur if someone else used the treestand without knowledge of its proper use, or if the treestand were dropped, hit by a motor vehicle or subject to corrosive conditions, etc. Summit Treestands have the highest structural integrity by design, material selection and manufacturing techniques, but as its owner, only your continued care will assure trouble free performance. When the above-mentioned guidelines are followed, your Summit Treestand will provide years of successful hunting.

### Tips

You will easily learn how to use your Summit treestand more efficiently and make it more effective for your hunting.

Changing your sitting position can relieve muscle stress and reduce fatigue. This will allow a longer hunt and perhaps an opportunity for a shot. Although it must be done slowly and quietly, repositioning and changing the height of your seat by raising or lowering the seat frame just a couple of inches could make a difference. This changes the hip to knee angle. Moving the seat straps, again slowly and quietly, forward or backward on their support bar will alter the sitting position also. Being comfortable will result in no movement and reduce being detected by game either from sight or from sound.



Figure 7

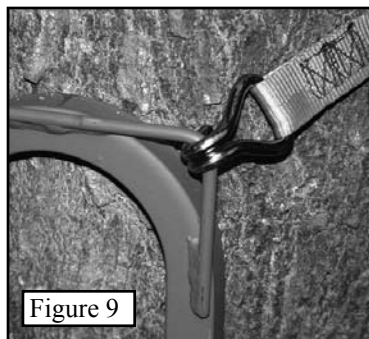

Figure 9



Figure 8

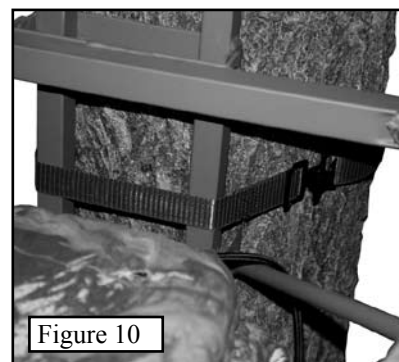

Figure 10

### Limited Warranty

#### (A) Warranty

Summit Treestands, LLC (Summit) warrants to the original retail purchaser that all products manufactured by it are free from defects in material and manufacture at the time of shipment for sixty (60) months from the date of purchase. Summit will repair or replace any part found defective if the unit claimed to be defective shall be returned to Summit, postage prepaid, within the warranty period.

This warranty shall not apply to any product which has been subjected to misuse; misapplication; neglect (including but not limited to improper maintenance); accident; improper installation; modification (including but not limited to use of unauthorized parts or attachments); adjustment or repair. THE FOREGOING IS IN LIEU OF ALL OTHER WARRANTIES, WHETHER EXPRESS OR IMPLIED (INCLUDING THOSE OF MERCHANTABILITY AND FITNESS OF ANY PRODUCT FOR A PARTICULAR PURPOSE), AND OF ANY OTHER OBLIGATION OF LIABILITY ON THE PART OF THE COMPANY.

#### (B) Limitation of Liability

It is expressly understood that Summit's liability for its products, whether due to breach of warranty, negligence, strict liability, or otherwise, is limited to the repair of the product, as stated above, and Summit will not be liable for any other injury, loss, damage, or expense, whether direct or consequential, including but not limited to loss of use, income, profit, or damage to material, arising in connection with the sale, installation, use of, inability to use, or the repair or replacement of Summit's products.

Summit reserves the right to make alterations or modifications in its products at any time, which in its opinion, may improve the performance and efficiency of the product. It shall not be obligated to make such alterations or modifications to products already in service.

Please fill out the warranty card and return to:

**SUMMIT Treestands, LLC.**  
**715 Summit Dr.**  
**Decatur, AL 35601**

**Parts List**

**BOX CONTENTS TROPHY CHAIR**

PN	DESCRIPTION	QTY
10922	Trophy Chair Seat Post Assy.	1
71121	Trophy Chair Support Assy.	1
85037	Trophy Chair Foam Seat	1
72023	Trophy Chair Packet	1

**72023 TROPHY SYSTEM ACCESSORY PACKET CONTENTS**

PN	DESCRIPTION	QTY
74223	12" Arm Pad	2
85051	In-Line Cable ties	4
30325	Cam buckle strap	1
30285	Tourniquet Strap with Buckle (green)	1
	2007 Instructional DVD	1
	Written instructions for Trophy Chair Assembly	
22023	Hardware Packet	1

**22023 HARDWARE PACKET CONTENTS**

PN	DESCRIPTION	QTY
10641	Short Shank Bushing	<b>6</b>
10605	3/4" Bolt (1/4 -20)	<b>4</b>
10612	Centerlock Nut (1/4 -20)	<b>4</b>
10628	Self Tapping Screw	<b>2</b>

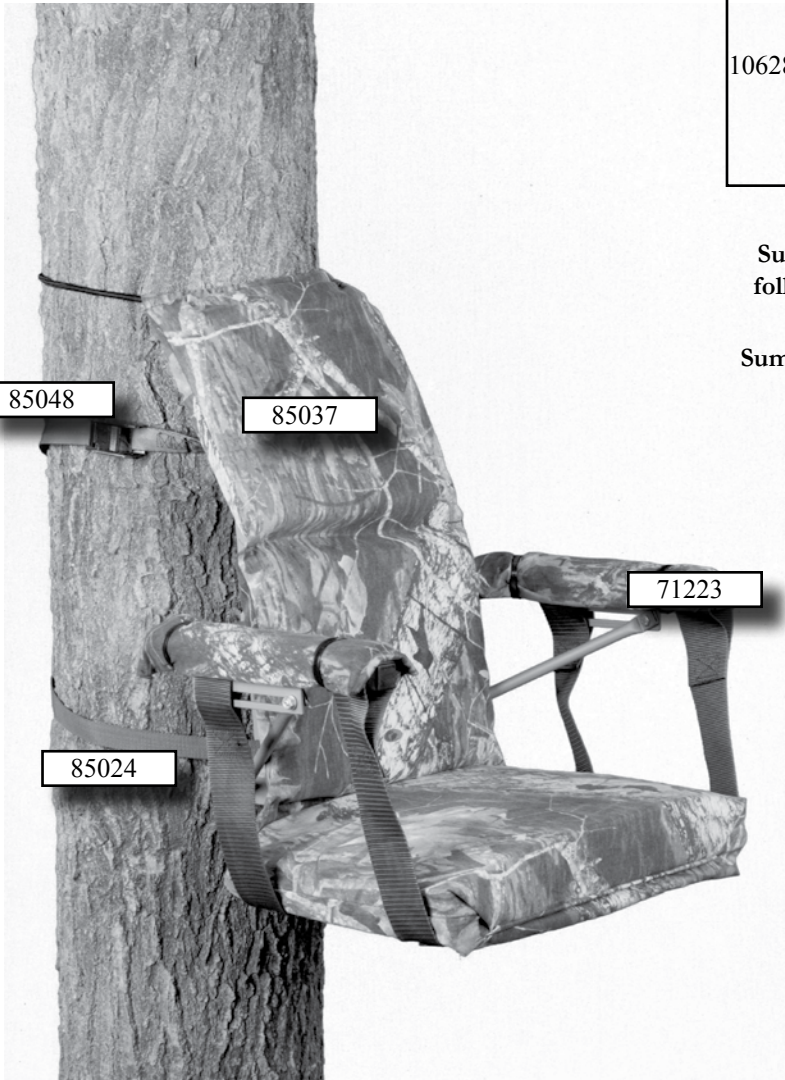

Summit products are manufactured under one or more of the following US Patents: 5,937,969; 5,971,104; 5,975,242; 5,979,603; 6,125,966; 6,182,792; 6,397,973; D,417,011; D,420,147

Summit Bucksteps and RapidClimb Stirrups are Patent Pending

**Visit us on the web at  
www.summitstands.com  
for accessories and  
upgrades!**

Cut Along Line

Cut Along Line

**Warranty Card for Summit Treestand**

Treestand Purchased: Trophy Chair (PN 82023)

Owners Name: \_\_\_\_\_ Street Address: \_\_\_\_\_

City: \_\_\_\_\_ State: \_\_\_\_\_ ZIP: \_\_\_\_\_ Phone: (\_\_\_\_) \_\_\_\_\_

Date Purchased: \_\_\_\_\_ Purchased From (Dealer Name): \_\_\_\_\_ Price \$: \_\_\_\_\_

Your heard about us through: Magazine  Advertisement  Video  Friend  Summit Catalog

Other  Please Explain: \_\_\_\_\_

You can also register your warranty card on line at: [www.summitstands.com/warranty.aspx](http://www.summitstands.com/warranty.aspx)