



Solo Deluxe Ladder Treestand

PN 82068

© 2012 Summit Treestands, LLC
715 Summit Dr. Decatur, AL 35601
(256) 353-0634
info@summitstands.com
www.summitstands.com



You **MUST** also view the enclosed DVD **BEFORE** using your new treestand!!

WEIGHT LIMIT

**SINGLE USER
300 LBS. X 1 TOTAL***

**DO NOT EXCEED THIS LIMIT!
(* Includes all gear)**

Stand minimum and maximum tree size: 8-20" diameter



You must fully read, understand and follow these warnings and instructions (written and video)! Failure to follow these instructions may cause serious injury or death!!

- **WHEN HUNTING FROM A TREESTAND FALLS CAUSING INJURY OR DEATH CAN OCCUR ANY TIME AFTER LEAVING THE GROUND!** FOR THOSE REASONS ALWAYS USE A FALL ARREST SYSTEM (FAS) COMPRISING A FULL BODY HARNESS AT ALL TIMES AFTER LEAVING THE GROUND. YOU MUST STAY CONNECTED AT ALL TIMES AFTER LEAVING THE GROUND WHILE USING ANY ELEVATED HUNTING PLATFORM. SINGLE SAFETY BELTS AND CHEST HARNESSES ARE NO LONGER ALLOWED AND SHOULD NEVER BE USED. IF YOU ARE NOT USING A FULL BODY HARNESS THAT IS PROTECTING YOU FROM A FALL, DO NOT LEAVE THE GROUND!
- READ AND UNDERSTAND ALL OF THE MANUFACTURER'S WARNINGS AND INSTRUCTIONS AND USE ALL SAFETY DEVICES PROVIDED. CONTACT SUMMIT TREESTANDS FOR ANY QUESTIONS. FAILURE TO DO SO COULD RESULT IN INJURY OR DEATH!
- A SIGNAL DEVICE SUCH A MOBILE PHONE, RADIO, WHISTLE, SIGNAL FLARE OR PERSONAL LOCATOR DEVICE (PLD) MUST BE ON YOUR PERSON AND READILY AVAILABLE AT ALL TIMES! ALWAYS INFORM SOMEONE OF YOUR HUNTING LOCATION, WHERE THE TREESTAND WILL BE LOCATED AND THE EXPECTED DURATION OF THE HUNT!
- DO NOT USE ANY TREESTAND UNLESS YOU ARE IN GOOD PHYSICAL SHAPE AND HAVE NO PHYSICAL LIMITATIONS OR MEDICAL CONDITIONS WHICH MAY PREVENT YOU FROM SAFELY USING THIS PRODUCT. ALWAYS CONSULT A PHYSICIAN IF YOU HAVE ANY QUESTIONS ABOUT YOUR PHYSICAL ABILITY TO USE THIS PRODUCT.
- NEVER USE A TREESTAND WHILE TAKING DRUGS, ALCOHOL OR CERTAIN PRESCRIPTION DRUGS! ALWAYS CONSULT A PHYSICIAN IF YOU HAVE ANY QUESTION ABOUT TAKING SPECIFIC MEDICATIONS AND USING THIS PRODUCT!
- NEVER USE A TREESTAND DURING INCLEMENT WEATHER SUCH AS RAIN, LIGHTNING, WINDSTORMS OR ICY CONDITIONS! END YOUR HUNT AND RETURN TO THE GROUND IF ANY OF THESE INCLEMENT CONDITIONS ARISE.
- NEVER USE A TREESTAND WHEN FEELING ILL, NAUSEOUS, DROWSY OR DIZZY!
- BE WELL RESTED AND NEVER HURRY. HURRYING CAUSES ACCIDENTS!
- CHECK EVERY LADDER SECTION CONNECTION EVERY TIME YOU USE THE STAND. IF ANY LADDER SECTIONS ARE SEPARATING - DO NOT USE THE STAND!
- NEVER USE A TREESTAND ON A DEAD, LEANING, DISEASED, LOOSE BARKED TREE, ON A UTILITY POLE OR ON TREES THAT HAVE ANY OBSTRUCTIONS THAT MAY LIMIT TREESTAND USE! NEVER RELY ON A TREE BRANCH FOR SUPPORT!
- CHECK THE GROUND UNDER THE LADDER STAND TO MAKE SURE IT IS FIRM AND LEVEL. SLOPING GROUND OR AN UNEVEN SURFACE (ONE LADDER SECTION ON A ROCK FOR EXAMPLE) CAN CAUSE YOUR STAND TO TILT OR SHIFT AS YOU CLIMB.
- ALWAYS MAINTAIN THREE POINTS OF CONTACT WHEN YOU CLIMB THE LADDER SECTION OF THIS STAND!
- NEVER JUMP OR BOUNCE ON A TREESTAND TO SECURE IT TO THE TREE!
- PULL UP A BOW, BACKPACK, FIREARM OR OTHER EQUIPMENT ONLY AFTER BEING SECURE IN THE TREESTAND. FIREARMS MUST BE PULLED UP UNLOADED, CHAMBER OPEN AND MUZZLE DOWN!
- NEVER MODIFY YOUR STAND IN ANY WAY BY MAKING REPAIRS, REPLACING PARTS, OR ALTERING ADDING OR ATTACHING ANYTHING TO IT EXCEPT IF EXPLICITLY AUTHORIZED IN WRITING BY THE MANUFACTURER!
- PRACTICE INSTALLING, ADJUSTING AND USING YOUR TREESTAND AT GROUND LEVEL PRIOR TO USING IT AT ELEVATED POSITIONS!
- INSTRUCTIONS (WRITTEN AND VIDEO) SHOULD BE KEPT IN A SAFE PLACE AND REVIEWED AT LEAST ANNUALLY. IT IS THE RESPONSIBILITY OF THE TREESTAND OWNER TO FURNISH THE COMPLETE INSTRUCTIONS TO ANY PERSON WHO BORROWS OR PURCHASES THE TREESTAND! THIS SUMMIT TREESTAND IS DESIGNED TO BE USED AS A COMPLETE SYSTEM - NEVER LOAN OR SELL ONLY A PORTION OF THIS TREESTAND SYSTEM.
- BEFORE EACH USE OF YOUR SUMMIT TREESTAND, ALWAYS INSPECT THE TREESTAND AND HARNESS FOR ANY DAMAGE, CRACKS, TEARS, CABLE WEAR OR ABRASION THAT MAY HAVE OCCURRED IN TRANSPORTING / STORING YOUR TREESTAND. DO NOT USE IF ANY DAMAGE IS FOUND! CONTACT CUSTOMER SERVICE FOR THE APPROPRIATE REPAIR / REPLACEMENT PROCEDURE!
- DO NOT LEAVE YOUR TREESTAND OUTDOORS WHEN IT IS NOT BEING USED! ANY STAND TUBING THAT IS ALLOWED TO FILL WITH RAINWATER AND FREEZE WILL RUPTURE OR BURST - DO NOT USE YOUR TREESTAND IF THIS OCCURS!

1 INDEX

GENERAL WARNINGS AND PRECAUTIONS, STAND WEIGHT LIMITS
 SECTION 1 - INDEX
 SECTION 2 - PARTS LIST
 SECTION 3 - TOOLS REQUIRED
 SECTION 4 - ASSEMBLY
 SECTION 5 - SETUP AND USE
 SECTION 6 - MAINTENANCE AND CARE
 SECTION 7 - HARNESS SUSPENSION INFORMATION
 SECTION 8 - LIMITED WARRANTY INFORMATION

PG 1
 PG 2
 PG 2
 PG 2
 PG 3 - 7
 PG 7 - 11
 PG 11
 PG 11
 PG 12

2 PARTS LIST

BOX CONTENTS

PN	DESCRIPTION	QTY
82068.010	LEFT UPRIGHT	1
82068.020	RIGHT UPRIGHT	1
82068.030	PLATFORM SUPPORT	2
82068.100	PLATFORM	1
82068.200	YOKE	1
82068.410	TOP LADDER SECTION	1
82068.420	MIDDLE LADDER SECTION	1
82068.430	BOTTOM LADDER SECTION	1
82068.440	STABILIZER MALE SECTION	1
82068.450	STABILIZER FEMALE SECTION	1
82068.300	ARMREST	2
82068.400	FOOTREST	1
82068.500	LEFT GUNREST ARM	1
82068.550	RIGHT GUNREST ARM	1
82068.600	GUNREST BAR	1
82068.850	FOAM SEAT	1
82068.855	GUNREST PAD	1
82068.700	ACCESSORY PACKET	1

ACCESSORY PACKET CONTENTS

PN	DESCRIPTION	QTY
82068.890	HARDWARE PACKET	1
82068.760	PLATFORM RATCHET WITH LOOP END	1
82068.765	PLATFORM SHORT STRAP FOR RATCHET	1
82068.770	SHORT LADDER STABILIZER STRAP WITH CAM BUCKLE	2
82068.775	LONG LADDER STABILIZER STRAP WITH LOOP END	2
82068.870	INSTRUCTIONAL DVD	1
82068.880	4 POINT HARNESS WITH TREE STRAP AND INSTRUCTIONS	1

Please call 256-353-0634 or visit <http://www.summitstands.com/contactus/> if you have any questions, if you need replacement parts, if you have any missing parts or if the included DVD does not play.

82068.890 - HARDWARE PACKET

All bolts used are 1/4" threads, grade 5.

PN	DESCRIPTION	QTY
10601	1 3/4" BOLT, 1/4x20	12
10609	2 1/4" BOLT, 1/4x20	4
10670	2 1/2" BOLT, 1/4x20	1
	2 3/4" BOLT, 1/4x20	2
10612	LOCK NUT, 1/4x20	19
	1/4" WIRE LOCK PIN	1
	1/4" BUSHINGS	4
	RUBBER BUMPERS FOR GUNREST	2

3 TOOLS REQUIRED

Tools

- 7/16" Wrenches and / or Socket / Ratchet

Use

Main Ladder Bolts / Nuts - 1/4x20 hardware

- Assembly can be made easier by the use of a powered ratchet or drill with socket adapter (take care not to overtighten when using power tools to assemble)
- It is recommended that all bolts be sorted by thread count / length prior to assembly.

4 ASSEMBLY

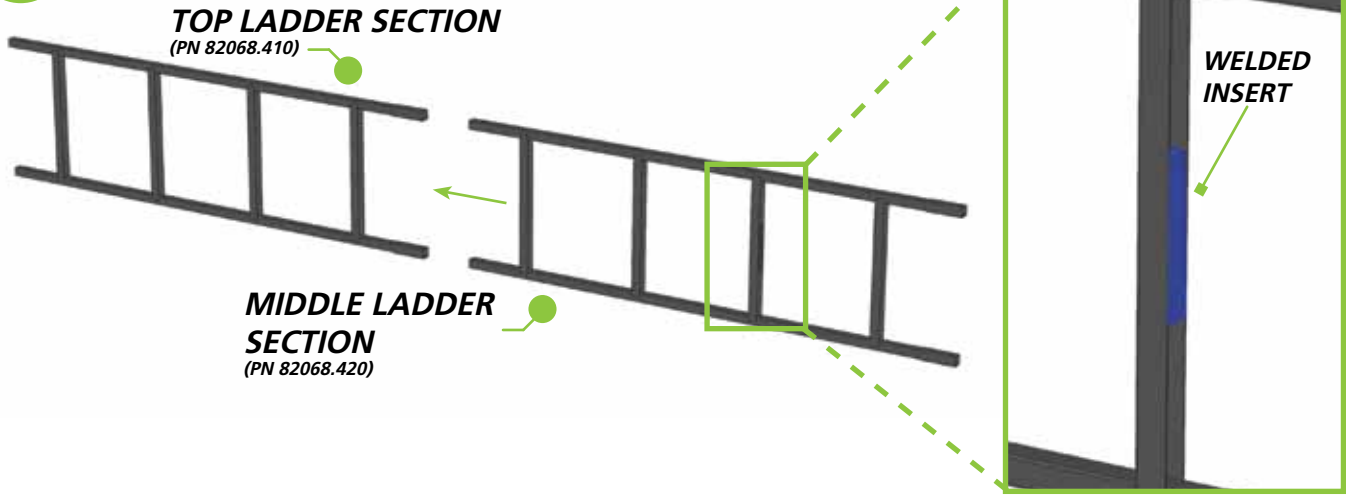

LADDER COLUMN

1. Position the Top Ladder Section and Middle Ladder Section as shown in **figure 1**. The stamped steel rung open ends should face the same on all ladder sections. The open end of the rung will face the ground.

The Middle Ladder Section has a welded metal insert on the second rung.

- 2. Slide the Ladder Sections together, line up the bolt holes and use one **1 3/4" bolt and lock nut** to secure each side (**figure 2**).
- 3. Position the Bottom Ladder Section as shown in **figure 3**. The **Bottom Ladder Section has no welded couplers**. Position it so the rungs face the same direction as the ladder sections in **Step 1**.
- 4. Slide the Ladder Sections together, line up the bolt holes and use one **1 3/4" bolt and lock nut** to secure each side (**figure 2**).

1 3/4" BOLTS, LOCK NUTS - WRENCH TIGHTEN

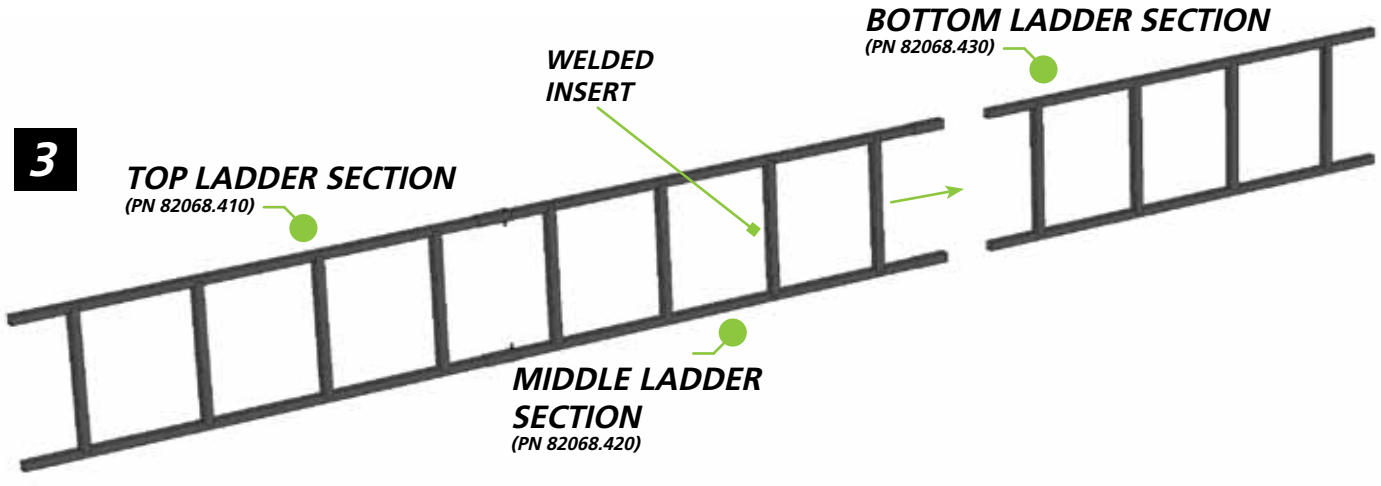
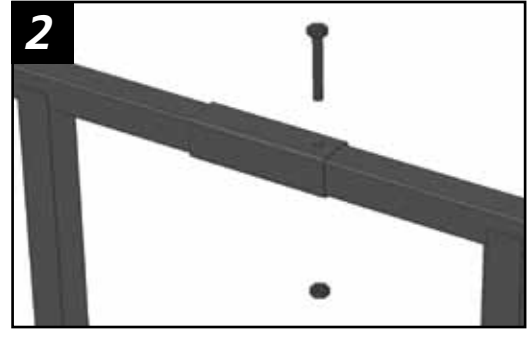

SEAT SUPPORT

1. Position the Left and Right Upright arms and the Yoke as shown in **figure 4**. Please note the correct orientation. The Upright arms should bend in at the middle and the teeth on the yoke should face down.
2. Slide the Upright arms onto the Yoke and line up the bolt holes.
3. Position the two Armrest bars as shown in **figure 5**. Note the correct orientation of the Armrests.
4. Secure the Armrests to the Upright tube / Yoke using two, **2 1/4" bolts and lock nuts** per side. (see **figure 6**)

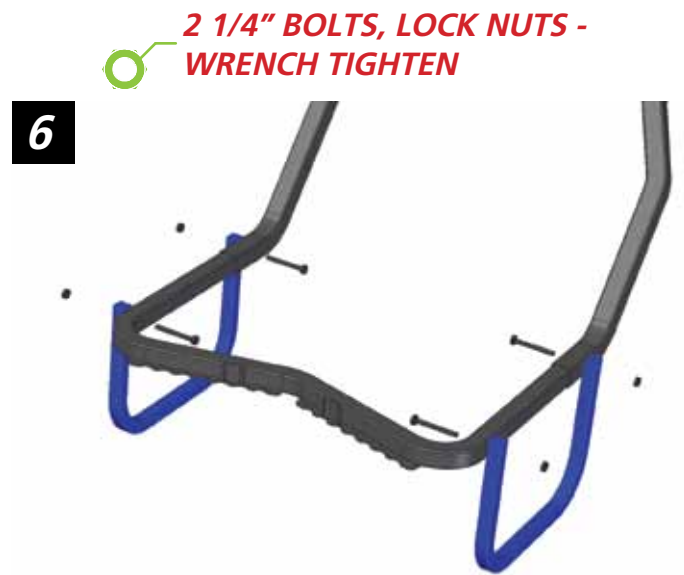
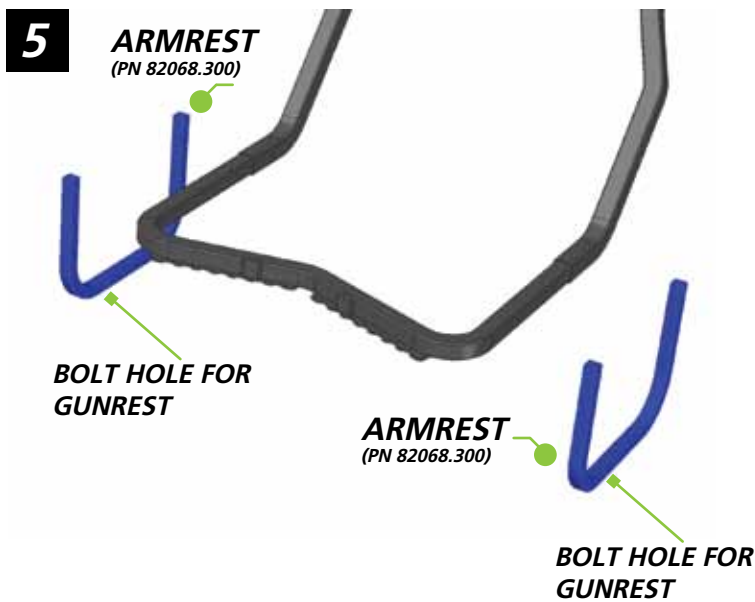
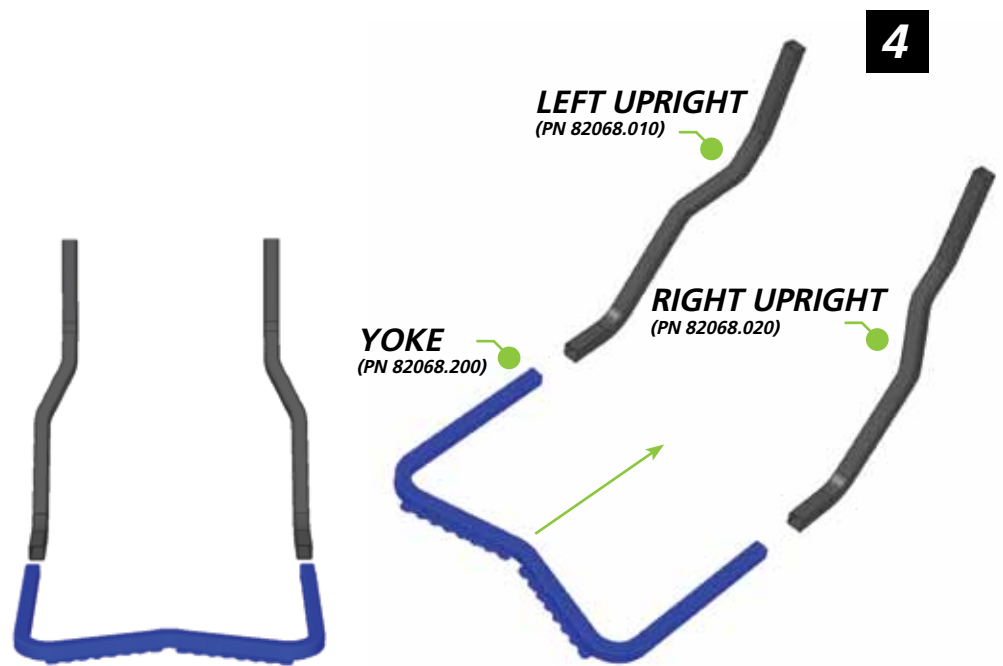

NOTICE

Summit recommends the use of the SOP Climbing System Accessory with all ladder and hang-on treestands. For more information please visit our website www.summitstands.com or by calling 256-353-0634.

PLATFORM

1. Position the finished Seat Support and Ladder Assembly as shown in **figure 7**. Note that the open end of the stamped rungs face down. Slide the Seat Support down onto the Ladder Assembly and line up the bolt holes.
2. Position the Platform Assembly as shown in **figure 8**.
3. Slide the platform forward and line up the bolt holes from **Step 1**.
4. Position the Footrest. Line it up with the same bolt holes as **Step 1 and 3**. Insert a **1/4" Bushing** between the Footrest and the Seat Support tubing. (*see figure 9*)
5. Secure the Footrest, Platform, Seat Support and Ladder Section using two **2 3/4" bolts and lock nuts** (*see figure 10*). Leave these bolts hand tight for now.
6. Position one of the Platform Support bars as shown in **figure 10**. The bar should run from the inside of the Upright to the outside of the Platform as shown.
7. Secure at the upper and lower hole using one **1 3/4" bolt and lock nut**. Leave these bolts hand tight until both bars are attached.
8. Repeat for the opposite side.
9. Wrench tighten bolts from **Steps 5 and 7**.

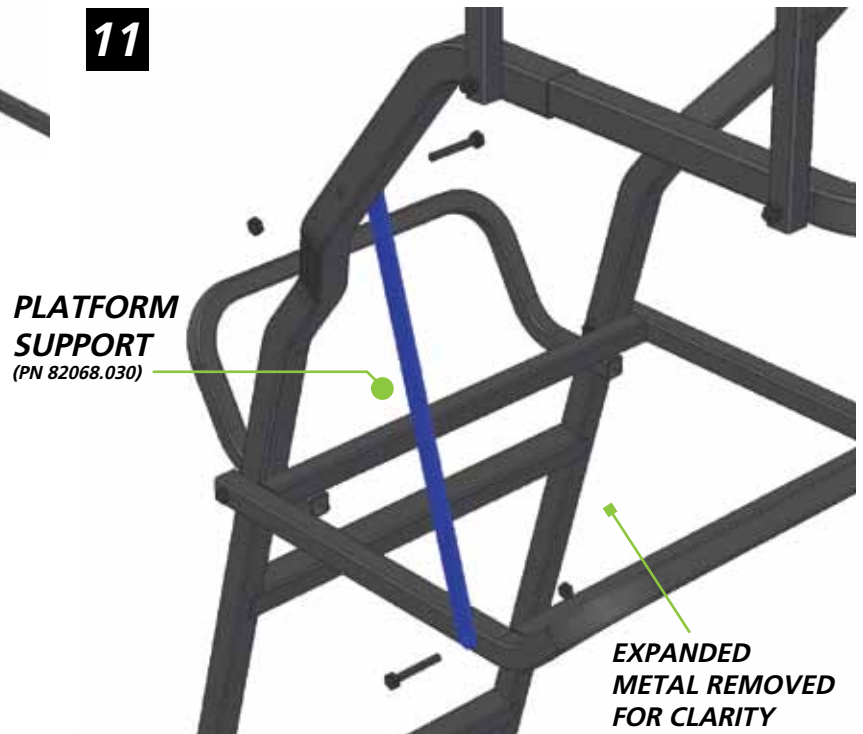
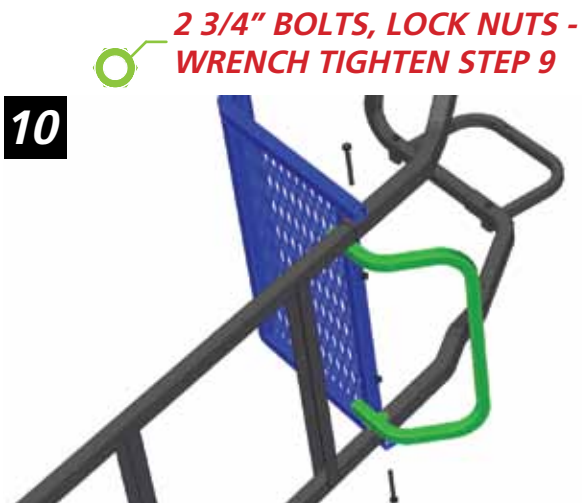
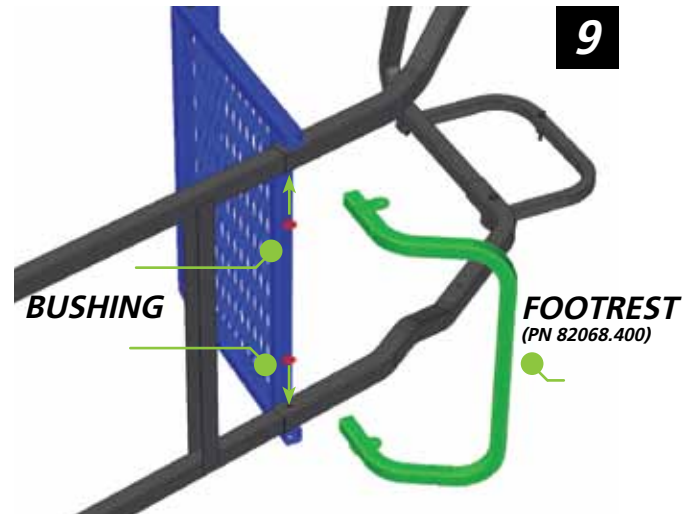
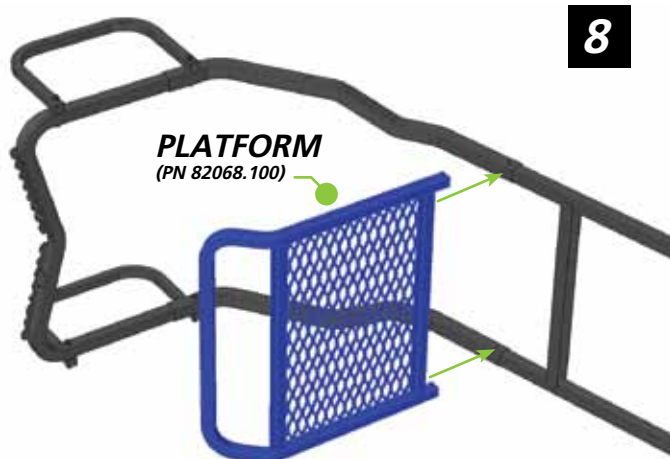
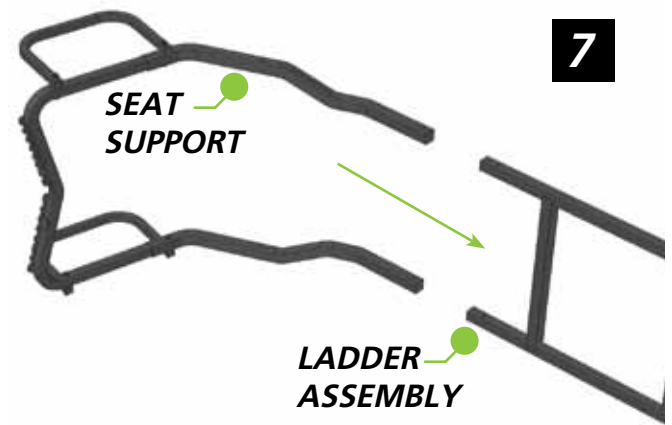

1 3/4" BOLTS, LOCK NUTS -
WRENCH TIGHTEN STEP 9

STABILIZER BAR

1. Position the Female Section of the Stabilizer bar as shown in **figure 12**. The Stabilizer bar will attach to the welded insert from the bottom.
2. Secure using one **2 1/2" bolt and lock nut**. (see **figure 13**)
3. Position the Male Stabilizer bar as shown (**figure 14**). Line up the bolt holes and secure using the **Wire Lock pin** as shown in **figure 15**. The Stabilizer bar has several holes to accommodate different tree sizes.

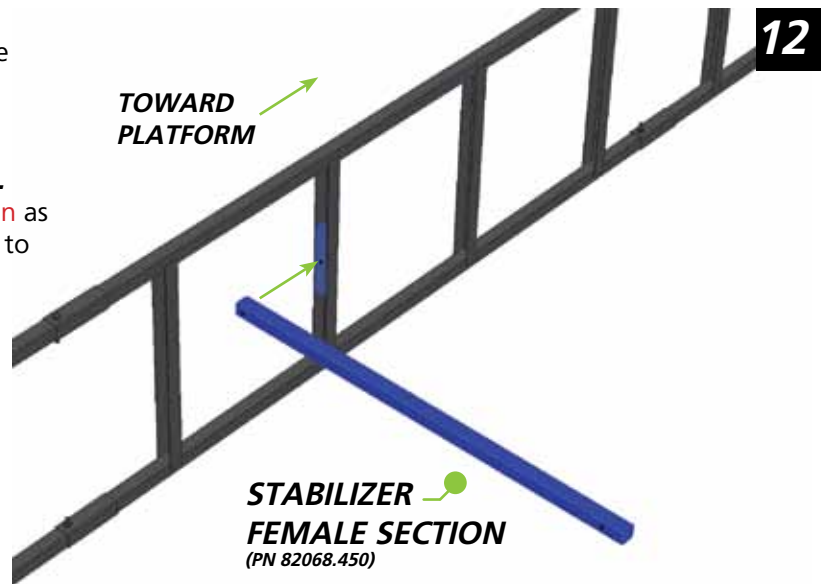

2 1/2" BOLT, LOCK NUT - WRENCH TIGHTEN

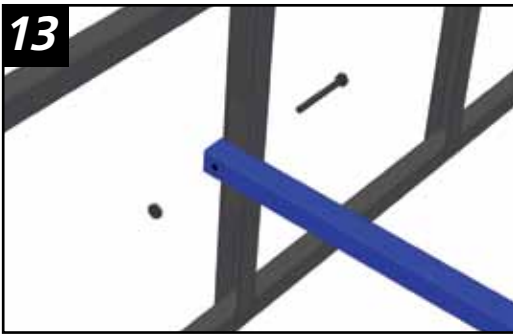

1 3/4" BOLT, LOCK NUT - WRENCH TIGHTEN

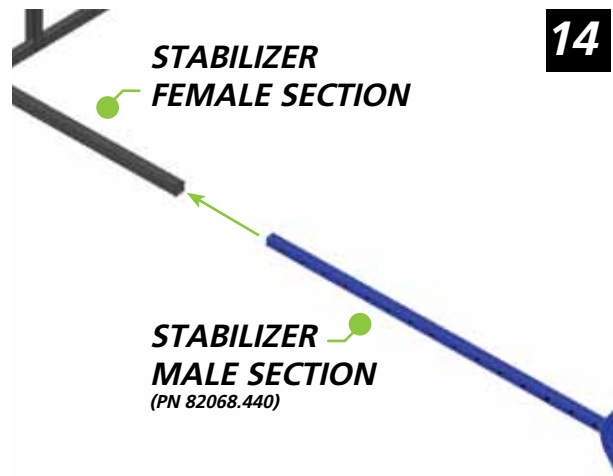

FOAM SEAT

1. Position the Foam Seat inside the frame as shown in **figure 16**. The thicker portion of the seat is the base.
2. Wrap the webbing straps over the bar and bring the buckles together under the seat.
3. Twist the smaller three bar slide buckle slightly sideways and push it through the larger D buckle as shown in **figure 17**.
4. The final buckle should look like **figure 18**. Repeat for the other strap.

FOAM SEAT (PN 82068.850)



NOTICE

The foam seat included with this treestand is removable for storage. **DO NOT** leave your stand outdoors when it is not being used.

GUNREST

1. Slide the Gunrest Bar onto the Left and Right Gunrest Arms as shown in **figure 19**.
2. Secure the Gunrest Bar using two **1 3/4" bolts with lock nuts** as shown in **figure 20**.
3. Insert two of the **Rubber Gunrest Bumpers** into the pre-drilled holes on each Armrest (**see figure 21**). Insert by pushing while twisting slightly.
4. Each Gunrest Arm has a tab with a pre-drilled hole. Line up these holes with the holes in the Armrests. Insert two **1/4" Bushings** between the Gunrest tab and Armrest hole (**figure 22**).
5. Use two **1 3/4" bolts with lock nuts** to secure the bar to the armrest (**see figure 23**.)
6. Position the Gunrest Pad as shown in **figure 24**. Secure by wrapping the pad around the bar and using the hook and loop strip to secure.

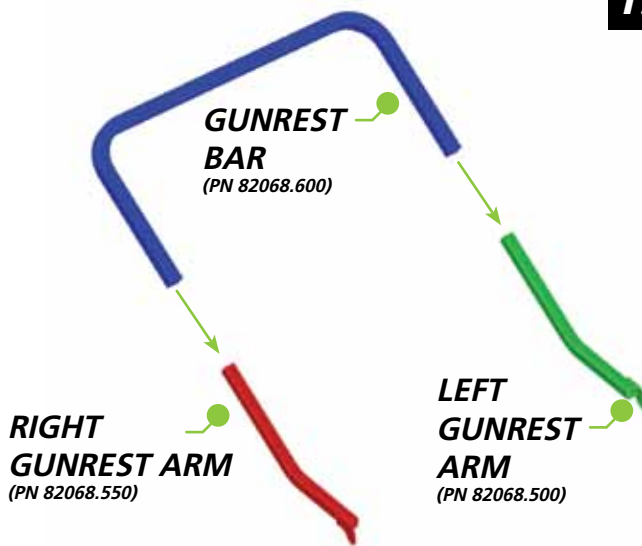

 **1 3/4" BOLT, LOCK NUT - WRENCH TIGHTEN**

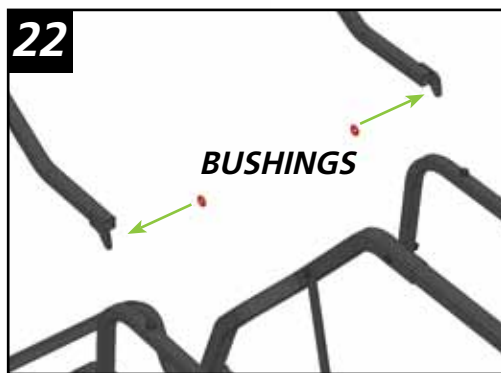
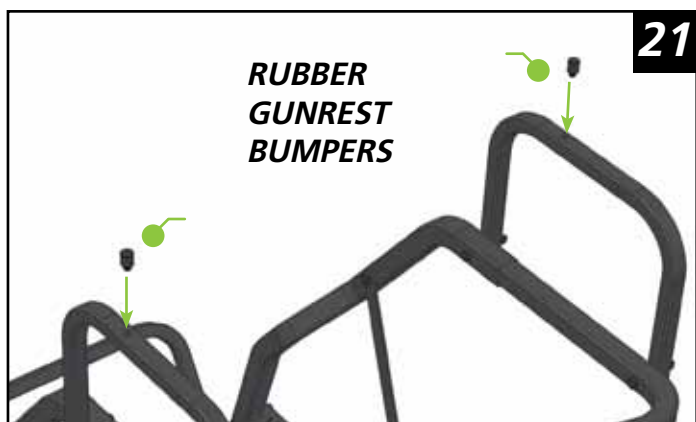
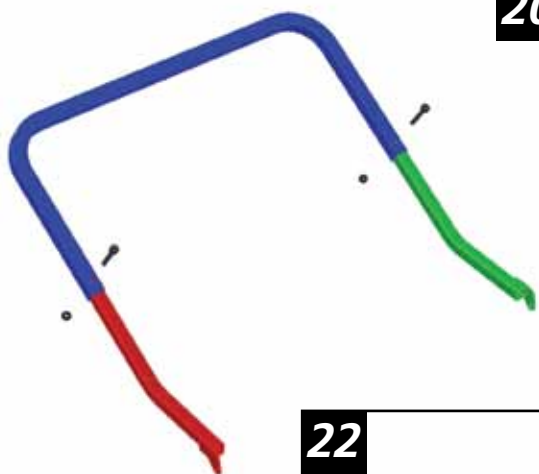

CAUTION
DO NOT use the Gun Rest Bar as a hand hold while climbing into or out of this stand.

 **1 3/4" BOLT, LOCK NUT - WRENCH TIGHTEN**

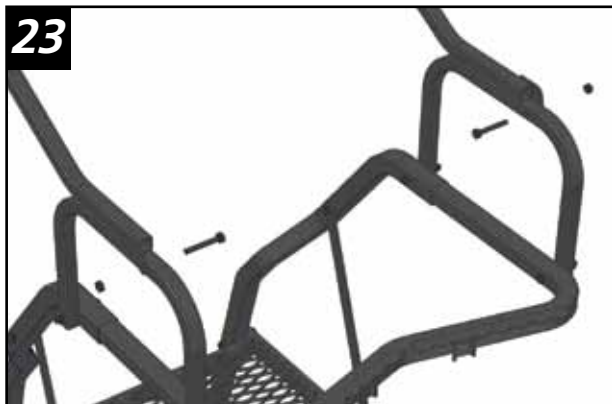

5 SETUP AND USE

PLATFORM RATCHET STRAP

1. Attach the Ratchet with Loop End to the **yoke tube** at location **A** as shown in **figure 25**. Put the sewn loop around the tube (**figure 26**) and then push the ratchet through the loop (**figure 27**) to create a cinch knot as shown in **figure 28**.
2. Attach the Short Strap for the Ratchet to the opposite **yoke tubing** at location **B** shown in **figure 25**. Loop the free end of the strap around the tube and then through the sewn loop. Pull to create a cinch knot. This is the platform tie down ratchet strap.

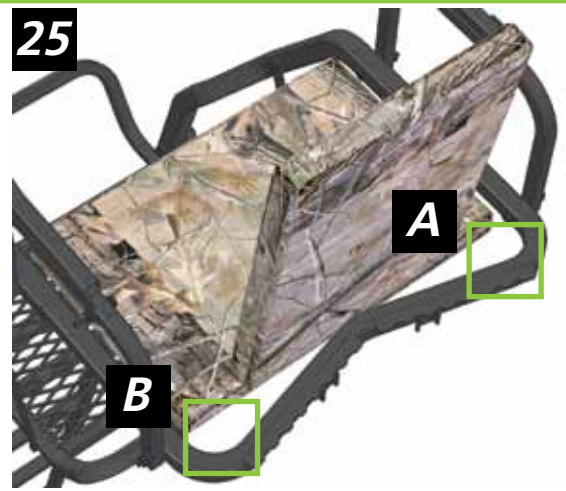

LADDER STABILIZER STRAPS (CAM BUCKLE)

1. Attach the two Long Stabilizer Straps to the **yoke tube** at locations **A and B** in **figure 25**. Use the same procedure from **Step 1** above to create a cinch knot for each strap. These are the two main ladder stabilizer straps.
2. Attach the Cam Buckle end of each strap to **the bottom ladder column** between the second and third rungs as shown in **figure 29**. Use the same procedure to create a cinch knot.
3. Before setup, run the Long Stabilizer Straps to the Cam Buckles and thread them as shown in **figure 30**. Pull the free end on both straps until they are tight.

These two straps provide support to the ladder column while you are setting your stand up and double as Stabilizer straps once the stand is in place.

⚠ WARNING
Never Wrap The Stabilization Straps Around The Ladder Rungs! Wrap Them Only Around The Ladder Columns! (see figure 29)

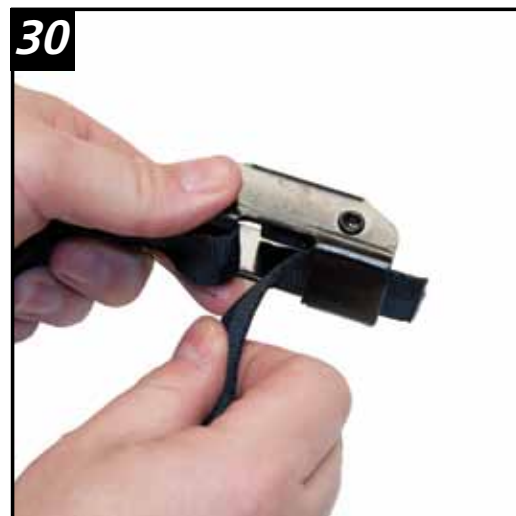

SETUP

⚠️ WARNING

It is required that at least three people initially set up the ladder stand. Always use two helpers!

⚠️ WARNING

Check the ground under the ladder stand to make sure it is firm and level.

⚠️ WARNING

Never use this ladder stand on dead, leaning, diseased or loose barked trees. Never use on a utility pole or on trees that have any obstructions that may limit treestand use. Never rely on a tree branch for support.

⚠️ WARNING

Always ensure the Stabilizer straps run from the upper attachment point to the ladder column BEFORE setup.

1. Position the ladder stand flat on the ground in front of an appropriate tree. The bottom ladder section should be placed approximately 3 feet from the base of the tree.
2. Using at least three adults, lean the ladder stand up into an upright position until the teeth make contact with the tree (*see figure 31*).
3. Pull the base of the ladder stand out until the platform is sitting level to flat ground as shown in *figure 32*.
4. While your helpers hold the stand securely, **LIGHTLY** bounce on the first rung to seat the ladder column into the ground.
5. Remove the wire lock pin from the Ladder Stabilizer bar shown in previous *figure 15*. Slide the Male Section of the stabilizer bar out until it makes contact with the tree as shown in *figure 33*. Reinsert the wire lock pin.

⚠️ WARNING

Do not force the Ladder Stabilizer bar from side to side to make it contact the tree.

6. Run the attached rope from one side of the Stabilizer bar, around the tree and tie it off to the other side of the Stabilizer bar.

NOTICE

The Stabilizer bar should lean down slightly when properly attached. This is normal.

7. With the ladder in place and secured by your helpers, unbuckle the two Long Stabilizer straps. Take the long straps and bring them around the back of the tree so that they form an X (*figure 34*).
8. Connect the left strap to the right cam lock buckle and connect the right strap to the left cam lock buckle. Pull the free end through the cam buckle as shown in *figure 30*. Repeat for both cam buckle straps.

31

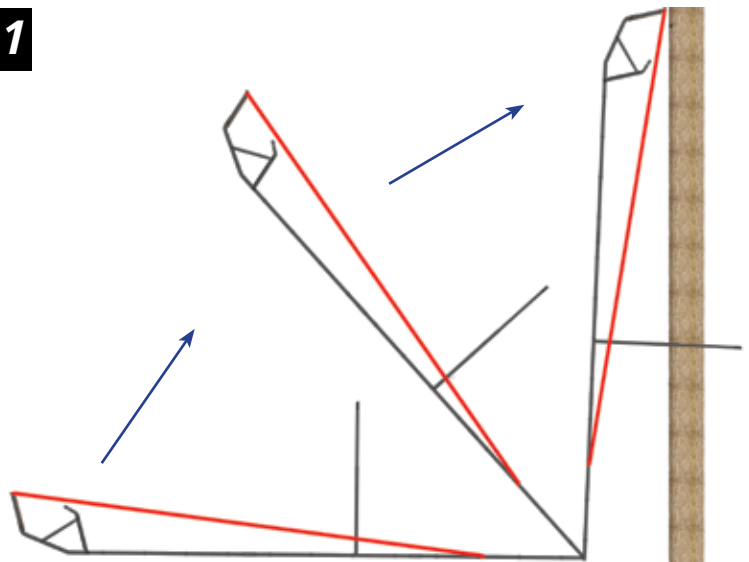

32

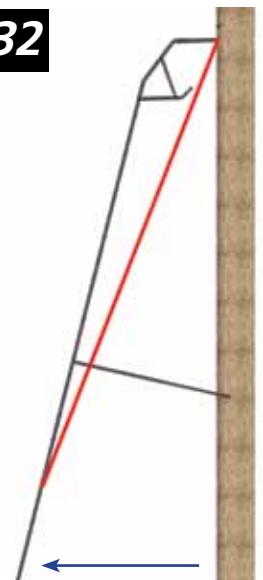

33



34



SETUP (continued)

9. Do not tighten until both straps are in place. Alternate between each strap until they are both tight. Do not overtighten. **Figure 35** shows the completed main strap setup.

⚠ WARNING
Never jump or bounce on any other part of the treestand in an attempt to force the platform to seat into the tree.

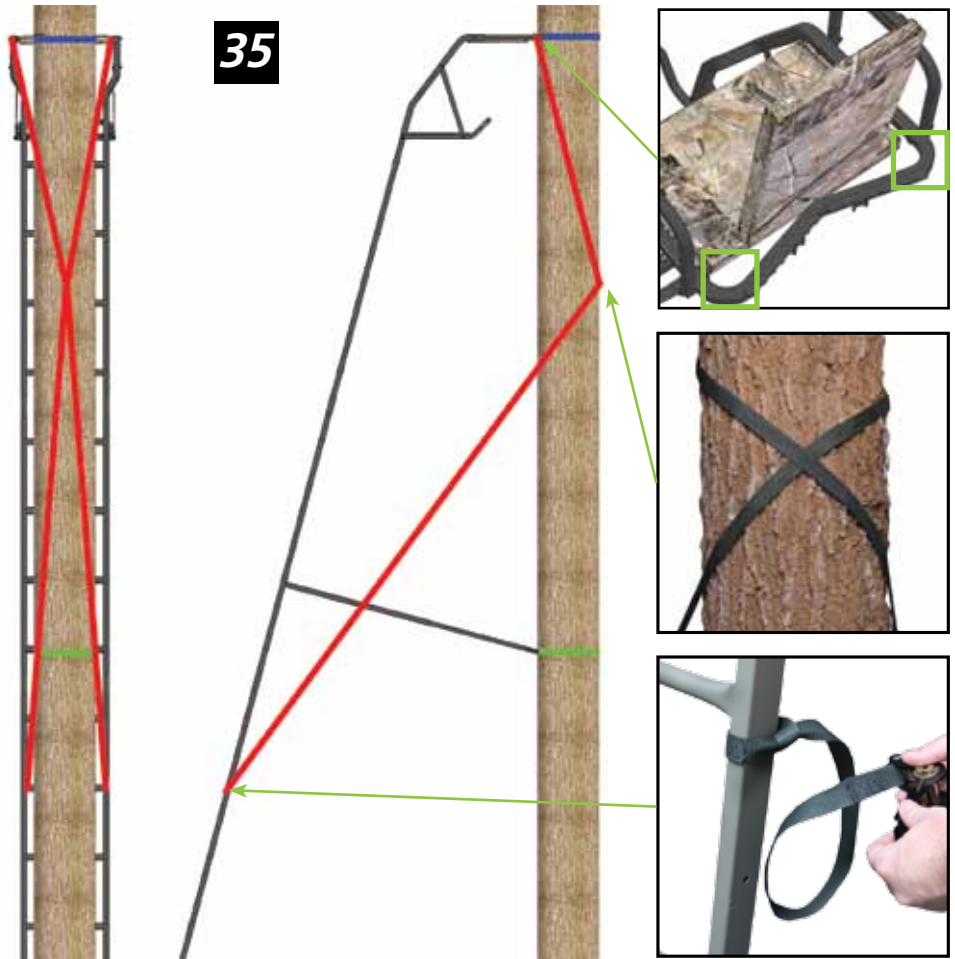

⚠ WARNING
You **MUST** now put on your safety harness if you have not already done so. **ALWAYS** refer to your harness instructions included with this stand for proper use of your safety harness.

⚠ WARNING
YOU WILL NOT be connected to a safety rope / strap while you climb into or out of this treestand. **USE EXTREME CAUTION** while ascending or descending the ladder. **TAKE YOUR TIME** and do not hurry.

⚠ WARNING
Always maintain three points of contact when you climb the ladder section of this stand. Always lean forward as you climb.

⚠ WARNING
This ladder **MUST** be held in place while it is ratcheted tight and while the top ratchet is put into place. Do not use until all straps are securely attached.



10. Have two of your helpers hold the ladder in place. **Carefully** climb the ladder. Once you are at the top, before stepping onto the platform, **IMMEDIATELY** attach your safety strap and harness to the tree.
11. Run the free end of the ratchet strap through the ratchet (**figure 36**) and tighten to secure the upper section to the tree.

USE

⚠ WARNING

ALWAYS check every ladder section connection every time you use the stand. If any ladder sections are separating - DO NOT USE THE STAND!

⚠ WARNING

NEVER disconnect from your safety harness or safety line while you are using this treestand.

1. Climb up and before stepping onto the platform **IMMEDIATELY** attach your safety strap around the tree above your seating position. **ALWAYS** refer to your harness instructions included with this stand for proper use of your Summit Safety harness and Safety Strap
2. **The length of the harness tether must be minimized at all times.** It should be adjusted so that it is above the head with no slack (snug) in the sitting position and you should have the minimum amount of slack possible when climbing.

6 MAINTENANCE AND CARE

The seat on this ladder stand is removable. We recommend it be removed and stored in a dry place when not in use.

The powdercoat finish applied at the factory is very durable and should only need touch ups in areas of heavy wear or accidental impact. The powder coat is applied only to the exterior surfaces of the treestand so it is possible for some surface rust to form inside the stand tubing. This is normal and should not affect the durability or performance of the stand. **This stand is made from Steel and as a result, rust may develop on any uncoated part of the stand** - including any area that has been nicked or scratched to the bare metal.

Should you damage any part of your Summit Treestand, contact your nearest authorized Summit dealer or the factory to obtain the proper corrective action procedure and/or replacement parts for the treestand.

⚠ CAUTION

Look for nicks, gouges, cuts, cracks, bends, corrosion or similar damage that can be the result of improper use or accidental damage. For instance, this could occur if someone else used the treestand without knowledge of its proper use, or if the treestand were dropped, hit by a motor vehicle or subject to corrosive conditions, etc.

Summit Treestands have the highest structural integrity by design, material selection and manufacturing techniques, but as its owner, only your continued care will assure trouble free performance. When the above-mentioned guidelines are followed, your Summit Treestand will provide years of successful hunting.

7 HARNESS SUSPENSION

It is necessary and very important that someone knows your hunting location and time of return. It is also very important that you carry (on your person) emergency communication devices such as a cell phone, two-way radio, whistle, signal flare or preferably a PLD (Personal Locator Device - FCC approved July, '03). When triggered, a PLD will transmit an emergency signal to local rescue teams identifying your location via satellite GPS coordinates. PLD's may be purchased at Wilderness outfitters or on the internet.

Suspension trauma or blood pooling can occur when suspended motionless in a harness for periods of time. This can lead to unconsciousness and death. A suspension relief strap is furnished with your harness. Read your harness instructions to assure that you know how to use it.

Self extraction may be necessary in the unfortunate situation that (A) no one knows your location, (B) your communication efforts are exhausted, (C) you are confident that you have the strength, dexterity and ability to perform self-extraction and (D) you decide this is your "absolute last resort". It is recommended to carry a device to assist with this self-extraction. Simple devices such as screw-in steps or a rope "Tree Descender" (available from Summit) will allow you to remove the weight from your harness. This may enable you to return to the treestand/ladder/climbing steps or slowly descend the tree.

⚠ WARNING

If you have to hang in the tree before help arrives, you need to exercise your legs by pushing off from the tree or by using the enclosed suspension relief strap. See the treestand harness instructions and the enclosed instructions for more information.

Several optional products/systems are available that offer self-recovery or self extraction from a fall when suspended in a harness. Returning to the ground obviously also relieves suspension trauma and some systems automatically descend the user while others allow user control. If one of these products/systems is selected for use as an additional safety precaution against prolonged suspension, be sure to follow the manufacturers' directions for safe use.

8 LIMITED WARRANTY

(A) Warranty

Summit Treestands, LLC (Summit) warrants to the original retail purchaser that all products manufactured by it are free from defects in material and manufacture at the time of shipment for **twelve (12) months from the date of purchase**. Summit will repair or replace any part found defective if the unit claimed to be defective shall be returned to Summit, postage prepaid, within the warranty period.

This warranty shall not apply to any product which has been subjected to misuse; misapplication; neglect (including but not limited to improper maintenance); accident; improper installation; modification (including but not limited to use of unauthorized parts or attachments); adjustment or repair. THE FOREGOING IS IN LIEU OF ALL OTHER WARRANTIES, WHETHER EXPRESS OR IMPLIED (INCLUDING THOSE OF MERCHANTABILITY AND FITNESS OF ANY PRODUCT FOR A PARTICULAR PURPOSE), AND OF ANY OTHER OBLIGATION OF LIABILITY ON THE PART OF THE COMPANY.

(B) Limitation of Liability

It is expressly understood that Summit's liability for its products, whether due to breach of warranty, negligence, strict liability, or otherwise, is limited to the repair of the product, as stated above, and Summit will not be liable for any other injury, loss, damage, or expense, whether direct or consequential, including but not limited to loss of use, income, profit, or damage to material, arising in connection with the sale, installation, use of, inability to use, or the repair or replacement of Summit's products.

Summit reserves the right to make alterations or modifications in its products at any time, which in its opinion, may improve the performance and efficiency of the product. It shall not be obligated to make such alterations or modifications to products already in service.

Please take the time to fill out the warranty card online at <http://www.summitstands.com/warranty> or fill out and mail in the enclosed warranty card.