



Instructions for Pro Hunter Feeder Kit

THANK YOU for your purchase of the **Pro Hunter Feeder Kit**, a top quality Moultrie product. Please read both sides of this sheet before operating this unit. If you should have any questions about this or any other Moultrie product, please contact us using the information on the reverse side.

To help us to better serve you, please complete and mail the enclosed Warranty Card.

I DRILLING YOUR DRUM/BARREL/BUCKET

NOTE: If you purchased a Moultrie Drum, go to II

Pro Hunter Feeder Kit will mount to the bottom of any drum or bucket.



- 1** Turn drum over, measure and mark the center of the bottom.
- 2** Center the template on the bottom of the drum and secure with tape. Drill two 3/16" Funnel holes and three 5/16" Feeder Leg holes.
- 3** Using a Hole Saw, drill a 2-1/4" hole in the center of the bottom of your drum.

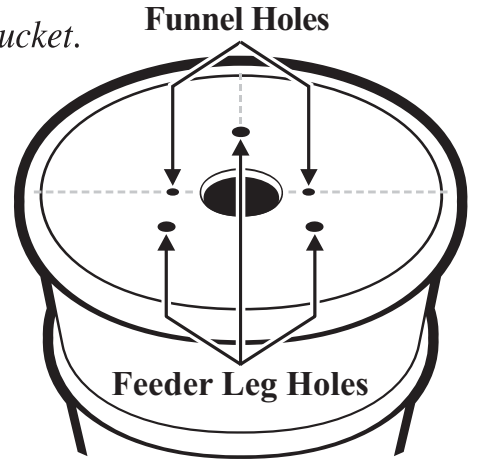

II MOUNTING THE FEEDER

- 1** After drilling holes (see above), place **Funnel** inside **Drum** with small end of funnel facing down, and attach with the two **Short Bolts** using nuts and washers provided.

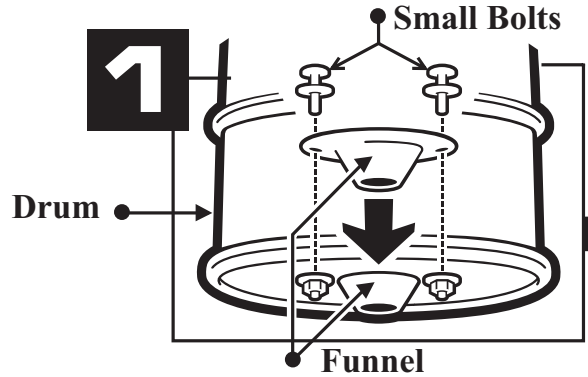
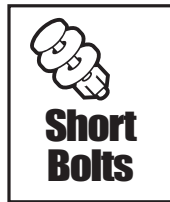

- 2** Turn **Drum** upside down.

- 3** Place **Feeder** on **Drum**. Attach **Feeder Legs** to **Drum** as shown with the **Long Bolts** using nuts and washers provided.



2 Turn upside down

3

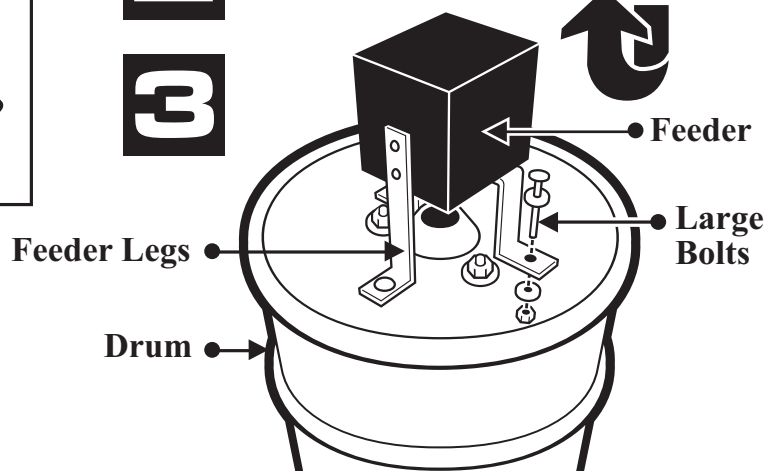

III INSTALLING BATTERY & OPERATING FEEDER



Install a 6-Volt Alkaline (ex. Energizer™) or Moultrie rechargeable battery by attaching the Red Alligator Clip to the positive terminal (+) and the Black Alligator Clip to the negative (-) terminal.

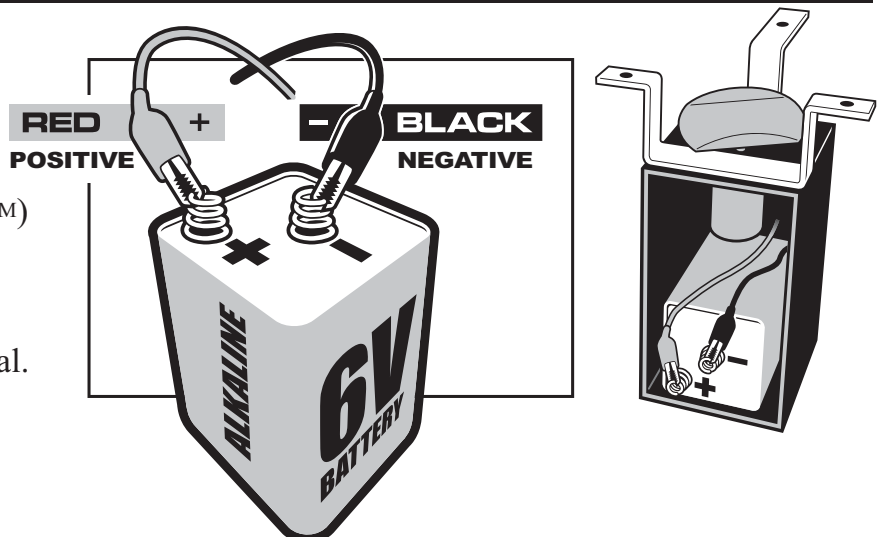

IV

SETTING THE CLOCK & PROGRAMMING FEEDER

Power Saving feature: your Pro Hunter is equipped with a power saving device which turns off the Display after 3 minutes of inactivity. To turn on the Display, simply press any button.

NOTE: the Display does not need to be showing a time in order for Feeder to operate normally.

To set time of day:

- 1) Press **MODE** button until **CLOCK SET** light comes on.
- 2) Press **UP** or **DOWN** buttons until correct time of day appears.
To scroll faster, press and hold **UP** or **DOWN** button.

NOTE: Make sure AM or PM is correct.

To set TIMER 1:

- 1) Press **MODE** button until **TIMER 1** light comes on.
- 2) Set feeding time by using the **UP** or **DOWN** buttons.
- 3) Make sure **AM** or **PM** is correct.
- 4) Press **MODE** button again. The display shows :00. Use the **UP** or **DOWN** button to set the amount of time the feeder will run. The chart below shows the approximate amount of feed dispensed based on this time setting:

Run Time (sec.)	4	6	8	10	12	14	16	18	20
Feed dispensed (lbs.)	.75	1	1.5	2	2.5	3	3.5	4	4.5

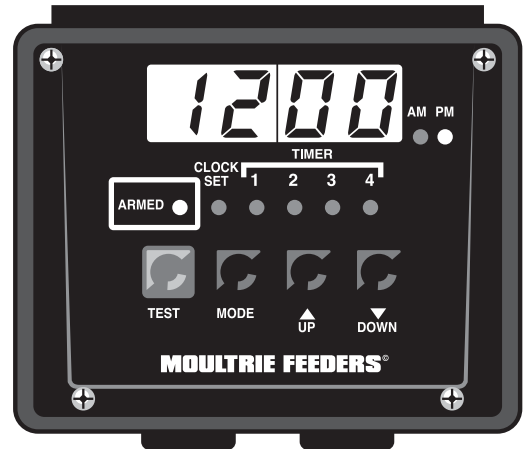

To set TIMERS 2, 3 and 4 (used for feeding more than once per day):

- 1) If feeding only once per day, the run time for **TIMERS 2, 3 and 4** should be :00.
- 2) To add feed times, press **MODE** button until **TIMER 2** light comes on and follow same instructions as for setting **TIMER 1**. Repeat for **TIMERS 3 and 4** if desired.

TESTING YOUR FEEDER



To test your Feeder:

The **TEST** button is useful when setting your feeder to dispense the correct amount of feed.

- 1) Press **MODE** button until the run time appears.
- 2) Press the **TEST** button. After a 5-second delay, the Feeder will cycle for the duration shown on the screen. Adjust run time by using the **UP** or **DOWN** buttons.

ARMING YOUR FEEDER

Before your Feeder will execute your Timer selections, you must arm the Feeder by pressing the **MODE** button until the **ARMED** light comes on. Feeder is now armed.

DISARMING YOUR FEEDER

To deactivate any Timer setting, set Timer run time to :00.

TIPS & POINTERS

1: (Q) When should I fill the drum on my feeder? (A) To prevent damage to the feeder kit, do not load drum until unit is off the ground.

2: (Q) I have a hanging feeder. What should I hang it with and how high should I hang it? (A) Some animals will chew through products like rope, so chain or steel cable is best. The bottom of the feeder should be about 7 feet from the ground.

3: (Q) What kind of feed should I use? (A) Whole kernel corn is recommended. Whole kernel corn mixed with soybeans or pellets is also effective for attracting deer. **NOTE:** When not mixed with corn, some pellet type feeds can take on moisture and clog the feeder.

4: (Q) How long should I set the feeder to run? (A) Many customers find that 4 or 5 seconds is long enough to establish a feeding pattern.

5: (Q) Some of the feed in the bottom of my drum never seems to move, and may be getting moldy. Any solution? (A) For 30 and 55 gallon barrels, Moultrie has developed internal funnels to solve this problem. The part numbers are **MFH-FUN30** for a 30-gallon drum and **MFH-FUN55** for a 55-gallon drum.

6: (Q) What should I do if my feeder isn't working? (A) Check the battery first by changing to a known good battery. If a problem still exists, call **Moultrie Customer Service** at the number below.

7: (Q) What type of battery should I use? (A) For best performance, use a rechargeable 6-Volt, 5 Amp Moultrie brand battery. If disposable batteries will be used in your unit, Energizer™ alkaline batteries are required for proper operation.

8: (Q) Can I get replacement parts for my feeder? (A) Yes, you may purchase the following **Moultrie** replacement parts.

- Hunter Hardware PackageMFH-81565
- Hunter MotorMFH-81694
- Metal Funnel & Spin Plate KitMFH-ASPF
- 6V Rechargeable BatteryMFH-RB6
- Universal Relacement TimerMFH-BC6

There are no other user-replaceable parts. If you have further questions, please call **Moultrie Customer Service** at the number below.

NOTE: This equipment has been tested and found to comply with the limits for a Class B digital device pursuant to Part 15 of the FCC rules. These limits are designed to provide reasonable protection against harmful interference in a residential installation. This equipment generates, uses and can radiate radio frequency energy and, if not installed and used in accordance with the instructions, may cause harmful interference to radio communications. However, there is no guarantee that interference will not occur in a particular installation. If this equipment does cause harmful interference to radio or television reception, which can be determined by turning the equipment off and on, the user is encouraged to correct the interference by one or more of the following measures:

- Reorient or relocate the receiving antenna
- Increase the separation between the equipment and the receiver
- Connect the equipment into an outlet on a circuit different from that to which the receiver is connected
- Consult the dealer or an experienced radio/TV technician for help



Our Service Department will gladly answer any questions you have.
Call 205-664-6700 Monday – Friday, 8:00 AM to 5:00 PM CST.
www.moultriefeeders.com



Instructions for 30 Gallon Hanging Feeder

THANK YOU for your purchase of the **Hanging Feeder**, a top quality Moultrie product. Please read this sheet before operating this unit. If you should have any questions about this or any other Moultrie product, please contact us using the information at bottom of page.

To help us better serve you, please complete and mail the enclosed Warranty Card.

I MOUNT YOUR FEEDER KIT TO DRUM

Using instructions provided with your Feeder Kit, mount your feeder and small funnel to the bottom of the Drum.

II INSTALL OPTIONAL LARGE FUNNEL

If you will be using an optional 30 gallon internal funnel (#MFH-FUN30), install per the instructions provided with funnel.

III INSTALL HANGING BRACKET

Insert steel rod with **Coupler Nuts** in **Drum**. With **Nuts** and **Washers** on outside of drum, Tighten eye bolts into **Coupler Nuts**.

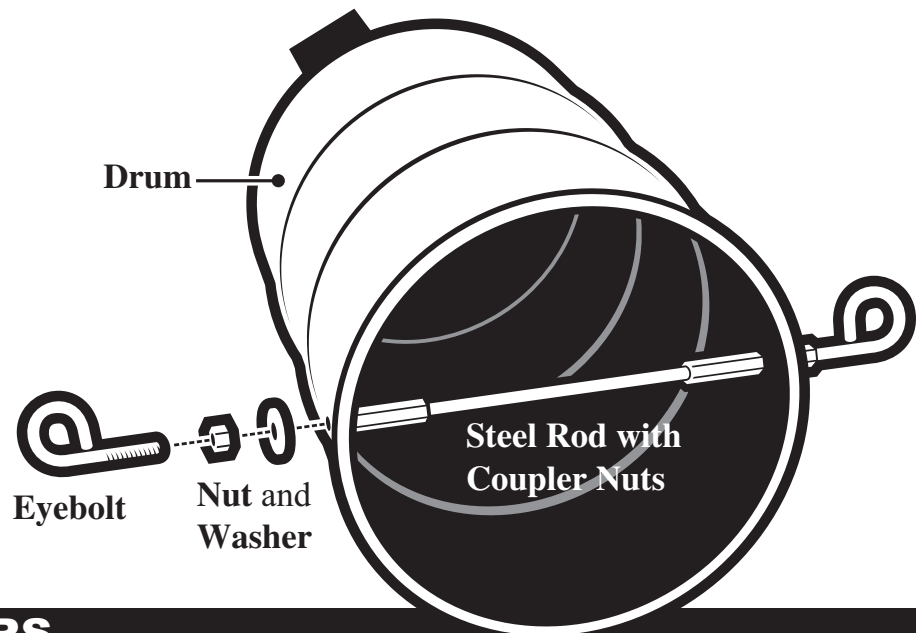

IV TIPS AND POINTERS

1: (Q) When should I fill the drum on my feeder? (A) To prevent damage to the feeder, do not load drum until unit is off the ground.

2: (Q) This is going to be heavy. How should I hang it? (A) A 30 gallon drum can hold up to 200 lbs. of feed; we suggest using block and tackle to raise to desired height, then secure as required.

3: (Q) What should I hang it with and how high should I hang it? (A) Some animals will chew through products like rope, so chain or steel cable is best. The bottom of the feeder should be about 7 feet from the ground.



Our Service Department will gladly answer any questions you have.
Call 205-664-6700 Monday – Friday, 8:00 AM to 5:00 PM CST.
www.moultriefeeders.com