



# Viper SS / Ultimate, Summit Goliath SS, Razor SS and Summit 180 SS / 180 Max SS

## Instruction Booklet - 2007

You **MUST** also view the enclosed DVD **BEFORE** using your new treestand!!  
Weight Limit (Viper SS / Ultimate, Razor SS, & Summit 180: 300 lbs. total.;  
Goliath SS, 180 Max: 350 lbs. total.) Tree Size: 8" - 20" Diameter - all models.  
**DO NOT EXCEED THESE LIMITS!**

**SUMMIT**  
EST. 1981  
**TREESTANDS**

---

### READ ME FIRST!!!

Please read carefully **BEFORE** using your new Summit Climbing Treestand.

Congratulations! You have purchased the finest commercially available treestand on the market today. Summit Climbing Treestands are designed and built to provide years of trouble-free, successful hunting with a minimum of maintenance and care. They are certified to meet the requirements of the Treestand Manufacturers Association (TMA) Standards. This booklet is provided to you to outline the recommended use, care and maintenance of your Summit Climbing Treestand.

### Warnings and Precautions

- **IT IS IMPORTANT TO NOTE THAT A TREESTAND FALL CAN OCCUR AT ANY TIME AFTER LEAVING THE GROUND!**
- **YOU MUST FULLY READ, UNDERSTAND AND FOLLOW THESE INSTRUCTIONS! PLEASE CONTACT SUMMIT TREESTANDS IF YOU HAVE ANY QUESTIONS ON THE USE OF THIS PRODUCT! FAILURE TO FOLLOW THESE INSTRUCTIONS MAY CAUSE SERIOUS INJURY OR DEATH!!**
- **BEFORE USING ANY TREESTAND, BE SURE YOU MAINTAIN FULL BODY SAFETY HARNESS ATTACHMENT TO THE TREE AT ALL TIMES AFTER LEAVING THE GROUND!!! YOU MUST STAY CONNECTED TO YOUR FALL ARREST SYSTEM AT ALL TIMES AFTER LEAVING THE GROUND!**
- **DO NOT USE THIS OR ANY OTHER TREESTAND IF YOU HAVE BEEN USING DRUGS (EVEN PRESCRIPTION) OR ALCOHOL OR ARE PHYSICALLY IMPAIRED IN ANY WAY! NEVER USE A TREESTAND WHEN FEELING ILL, NAUSEOUS OR DIZZY!**
- **FOR YOUR SAFETY, DO NOT USE ANY TREESTAND DURING RAIN, LIGHTNING, WINDSTORMS, WHEN TREES ARE WET OR ICY, OR ON TREES THAT ARE LEANING, TREES THAT APPEAR DEAD OR DISEASED, LOOSE BARKED TREES OR ON UTILITY POLES!!! NEVER RELY ON A TREE BRANCH FOR SUPPORT!**
- **DO NOT USE ANY TREESTAND IF YOU HAVE NOT FOLLOWED THE MANUFACTURERS CARE AND MAINTENANCE GUIDELINES! NEVER MODIFY YOUR STAND BY MAKING REPAIRS, REPLACING PARTS, ALTERING PARTS OR ATTACHING ANYTHING TO IT UNLESS EXPLICITLY AUTHORIZED BY SUMMIT TREESTANDS!**
- **ALWAYS INSPECT THE STAND / CABLE SYSTEM OR HANGING STRAPS AND ANY SAFETY GEAR BEFORE EACH USE! IF ANY PROBLEMS ARE FOUND - DO NOT USE THE STAND! CONTACT CUSTOMER SERVICE FOR THE APPROPRIATE REPAIR / REPLACEMENT PROCEDURE!**
- **NEVER ALLOW THE SAFETY HARNESS TETHER TO GET UNDER OR AROUND YOUR NECK!**
- **IT IS IMPORTANT THAT YOU REMEMBER TO BE PREPARED IF YOU HAPPEN TO FALL AND EMPLOY YOUR SAFETY HARNESS WHILE IN A TREESTAND. STAY CALM AND DO NOT PANIC. YOU MUST BE PREPARED TO RECOVER FROM YOUR FALL BY EITHER CLIMBING BACK ONTO YOUR TREESTAND OR USING A DEVICE SUCH AS THE "TREE DESCENDER" (AVAILABLE FROM SUMMIT, WWW.SUMMITSTANDS.COM, 256-353-0634). PRIOR TO HUNTING: YOU MUST NOTIFY SOMEONE OF YOUR HUNTING LOCATION AND WHEN YOU WILL RETURN!**
- **DO NOT USE ANY TREESTAND UNLESS YOU ARE IN GOOD PHYSICAL SHAPE. THE ABILITY TO DO SEVERAL PUSH-UPS, CHIN-UPS, SIT-UPS, ETC. IS REQUIRED FOR YOUR SAFETY!**
- **ALWAYS USE A HAUL LINE TO RAISE AND LOWER UNLOADED FIREARMS AND BOWS! FIREARMS MUST BE PULLED UP UNLOADED, CHAMBER OPEN AND MUZZLE DOWN!**
- **NEVER CLIMB WITH ANYTHING IN YOUR HANDS OR ON YOUR BACK - USE A HAUL LINE!**
- **PRACTICE USING YOUR TREESTAND AND SAFETY HARNESS AT A LOW LEVEL (5 FEET) UNTIL YOU MASTER ITS USE!**
- **BE WELL RESTED AND NEVER GET IN A HURRY. HURRYING CAUSES ACCIDENTS!!**
- **INSTRUCTIONS (WRITTEN AND VIDEO) SHOULD BE REVIEWED AT LEAST ANNUALLY. IF YOU LOAN OR SELL THIS TREESTAND, IT IS YOUR RESPONSIBILITY TO FURNISH THE BUYER A COPY OF THESE INSTRUCTIONS AND THE VIDEO THAT CAME WITH THE TREESTAND. MAKE SURE THEY WATCH THE VIDEO AND READ / UNDERSTAND THE INSTRUCTIONS!**
- **UNDER NO CIRCUMSTANCE SHOULD YOU EVER RELEASE THE CABLE FROM THE STAND TO MAKE ADJUSTMENTS ONCE YOU ARE OFF THE GROUND!!!**

---

### Warning

Before each use of your Summit Treestand, **ALWAYS** inspect the treestand for any structural damage, cracks, cable wear or abrasion that may have occurred in transporting your treestand. **DO NOT USE IF ANY DAMAGE IS FOUND! DO NOT** leave your treestand outdoors when it is not being used. **Any tubing that is allowed to fill with rainwater and freeze WILL rupture or burst. DO NOT use your treestand if this happens.**

## Section 1. Assembling Your New Treestand.

Please contact us at [www.summitstands.com](http://www.summitstands.com) or 256-353-0634 to obtain any missing parts or if your DVD does not work.

Please refer to the additional instruction sheet for Ultimate Viper Accessory instructions.

**Comfort Pads.** The camouflaged foam pads for the frame can be easily attached for additional comfort and noise reduction. The cable ties for attaching the pads are “in-line” cable ties: Note the correct and incorrect ways of attaching. To attach - pull the cable ties snug, cut off the excess, and rotate the clasp to the underside of the pad. The Viper SS / Ultimate and Razor SS have two short arm pads and one longer pad. Attach the short pads to the arms with the opening down as shown in **Figure 1**. Two cable ties per pad is sufficient. On the Viper SS / Ultimate, place the long pad over the front of the seat bar with equal lengths extending on each side and with the opening down. On the Razor SS, place the long pad on the folding climbing bar with the opening down. Use the remaining cable ties to secure the pads. The Goliath SS and Summit 180 have one long pad that covers the front bar and the arm rails. Slip the pad over with the opening down and attach with the supplied cable ties.

**Backpack Straps.** The backpack straps consist of three parts - two 1” wide straps each with sewn in loop and a 2” wide strap with buckles and a loop sewn in. Place the looped end on the 2” wide strap around the middle of the second platform rung from the front of the stand as shown in **Figure 2**. Push all of the remaining 2” strap through the loop as shown in **Figure 3**. Place the looped end of the 1” wide strap around the stand tubing (A) and bring the loose end back through the loop as shown in **Figure 4**. Repeat for other side. Thread the loose end of each 1” strap through the buckle on the 2” strap as shown in **Figure 5**. The completed assembly should look like **Figure 6**.

**RapidClimb Stirrups.** The two (2) RapidClimb stirrups fit on the curved upright arms of the platform. Simply slide one stirrup on each side of the platform so that they are on the inside of the platform and facing down as shown in **Figure 7**. Once positioned, secure with the bolt and wing nut provided as show in **Figure 8**. Occasional readjustment may be required as your footwear needs change. Wrap the supplied bungee cord around one side of the curved platform upright bars and push the S-hook through the loop as shown in **Figure 9**. Hook the S-hook around the opposite curved platform upright bar and back onto itself as shown in **Figure 10**.

**Viper SS, Goliath SS, Razor SS Seat Attachment.** The seats on these stands are removable. **DO NOT** reverse the seats on these stands. **DO NOT** leave your stand outdoors when you are not using it. See **Figure 11** for buckle usage diagram.

**Summit 180 Seat Attachment.** The seat on the Summit 180 can face towards the tree (for climbing) or away from the tree. **DO NOT** leave your stand outdoors when you are not using it. See **Figure 11**.

**Climbing Bar Attachment (Razor SS Only).** Please refer to the back of this booklet for diagrams and parts descriptions. Place 4 long shank bushings into the four holes in the ends of the supplied climbing bar as shown in **Figure 12**. Place two short shank bushings in the holes on the outside of the U bracket attached to the climber portion of the stand - repeat for other side - shown in **Figure 13**. **Position the climbing bar so that the small welded-on bracket is facing up (Figure 14)**. Slide the climbing bar ends into the U brackets and secure with one 2” bolt and one lock nut per side - Shown in **Figure 15**. Place two short shank bushings in the outside of the remaining bracket on the climbing bar as shown in **Figure 16**. Insert the remaining short shank bushings into the hole on the bar support struts - One per strut. Secure the support strut to the bracket using the 3/4” bolt

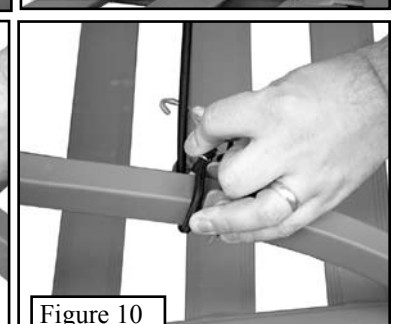
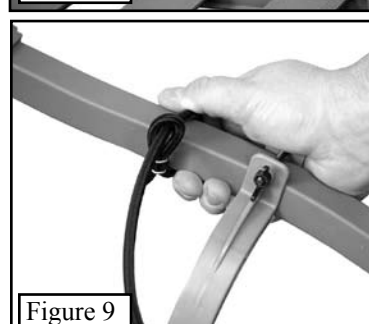
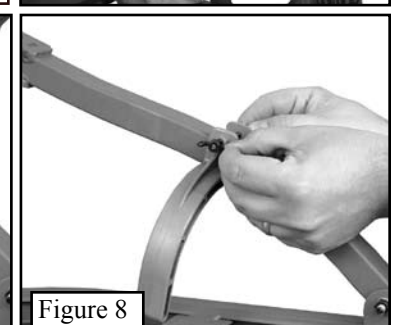
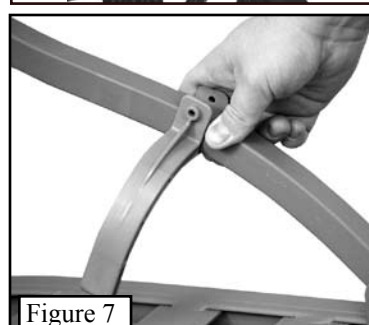
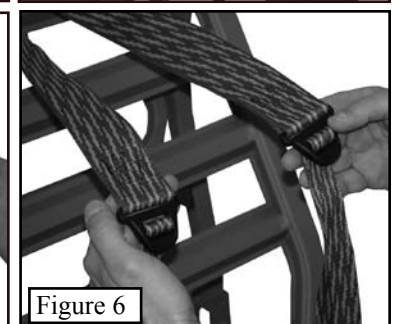
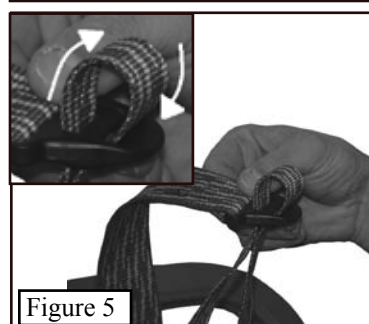
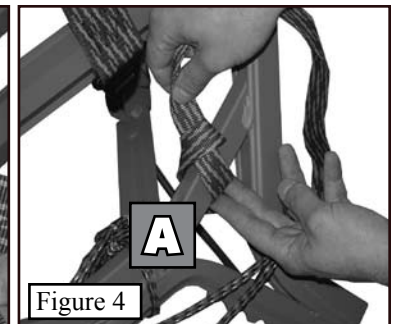
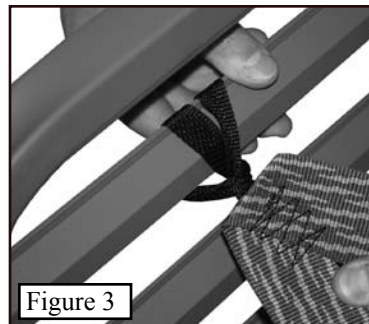
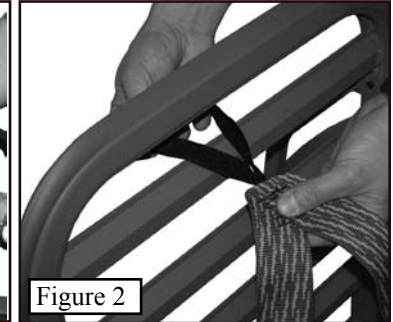
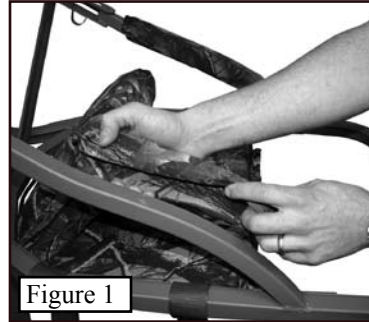
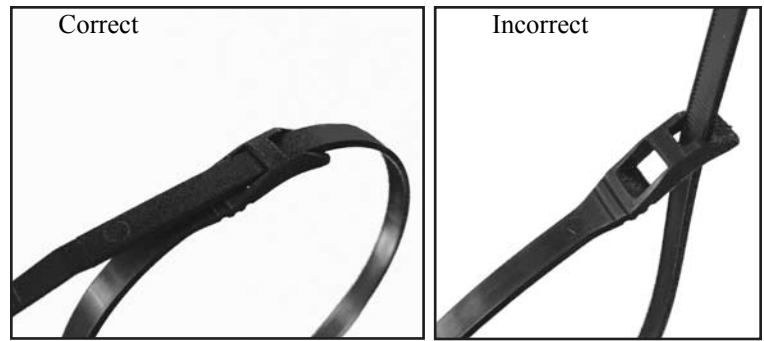

and lock nut. Support strut must attach to the outside of the bracket as shown in **Figure 17**. Slide the 1/4" tall **METAL** bushing onto the 1 3/4" shoulder bolt. Slide the 15/16" tall nylon spacer into the open end of the stand tubing on the climber. Line up the holes. You may have to remove some metal flashing from around the pre-drilled holes. This step is easier to do if the climber is laying on its side. Insert the shoulder bolt and **METAL** bushing into the hole at the end of the tubing and through the nylon spacer. The large, washer side of the Metal bushing should fit flush with the **OUTSIDE** of the climber tubing as shown in **Figure 18**. Secure with the remaining lock nut and repeat for the other side.

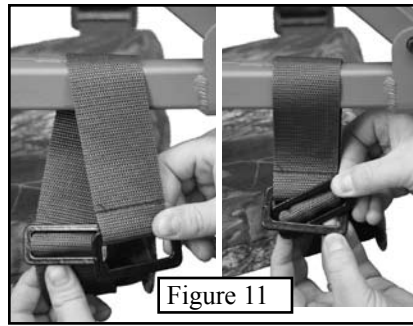

Figure 11



Figure 12

**Section 2. Use of the Viper SS / Ultimate, Goliath SS, Razor SS, Summit 180 SS / 180 Max SS Climbing Treestand (NOTE: Footrests Shown are NOT INCLUDED and may be purchased separately at [www.summitstands.com](http://www.summitstands.com)).**

**Part 1. Attachment To The Tree.**

**Step 1.** Attach the base platform to the tree first. To do this, pull down and hold the QuickDraw cable spring as shown in **Figure 19**. This will release the locking tab from the cable, allowing you to remove it from the cable bracket.

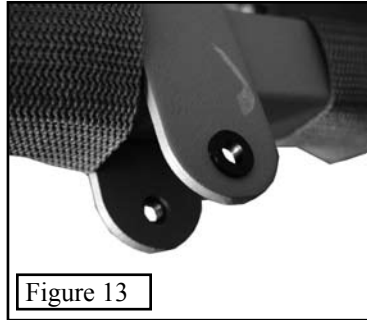

Figure 13

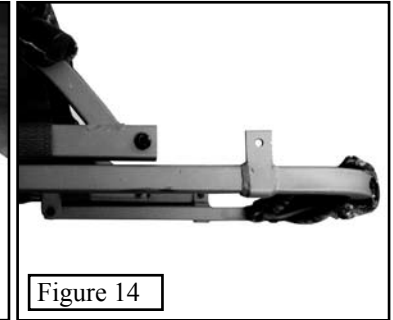

Figure 14

**Step 2.** Take one end of the cable around the tree and begin to slide it down into the tubing as shown in **Figure 20**. Once the cable slides easily into the tubing (it helps to bend the cable upward while pushing down on it), you are ready to place it in its final position.

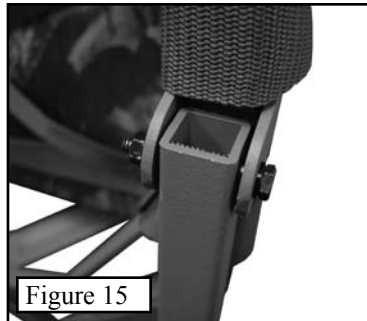

Figure 15

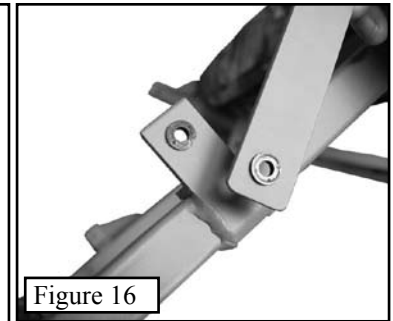

Figure 16

**Step 3.** Pull the cable towards the back of the tree and "seat" one of the cable stops against the back of the bracket, as shown in **Figure 21**. The QuickDraw cable spring will "lock" into place behind one of the cable stops.

**Step 4.** Your cable bracket should now look like **Figure 22**.

**WARNING:** If the QuickDraw cable spring does not lock into place behind the cable stop, **DO NOT USE THE TREESTAND!** Contact Summit to obtain the proper corrective action.

**Step 5.** If necessary, go to the other side of the tree and position the other end of the cable by repeating the steps of pulling the QuickDraw cable spring, sliding the cable into the tubing, and assuring that the QuickDraw cable spring has locked into position.

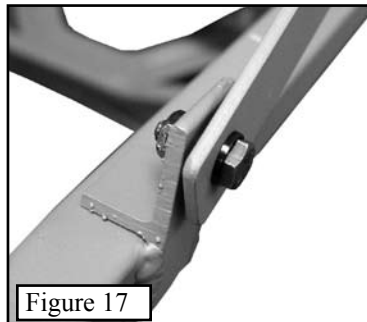

Figure 17

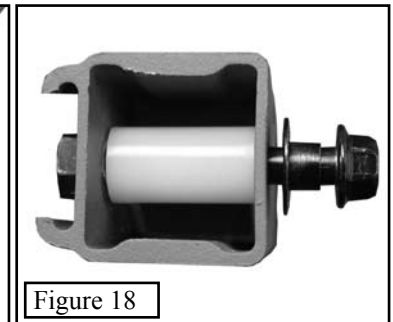

Figure 18

**NOTE:** The sole purpose of the plastic coating on the cable is to eliminate noise. After some use you may notice some abrasions, peeling or possibly cuts in the coating. This coating does not affect the performance or safety of your treestand. It is there to eliminate unnecessary noise when sliding the cable down into the tubing.

**WARNING: DO NOT USE THE CABLE IF IT HAS BROKEN OR DAMAGED METAL STRANDS!** Call immediately to order a replacement if this should occur.

To ensure that your treestand is level at the height at which you will be hunting, observe the relative change in the tree diameter between the base of the tree and the final treestand height. It is very important to adjust the treestand base platform and seat at the base of the tree such that the treestand base platform will be level at the height you hunt. Trees commonly found in swamp or marsh areas have a tendency to swell at their base, and these may require a greater starting angle in order for your treestand to be level - as compared to a normally tapered tree.

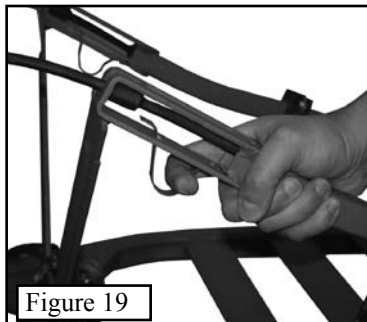

Figure 19

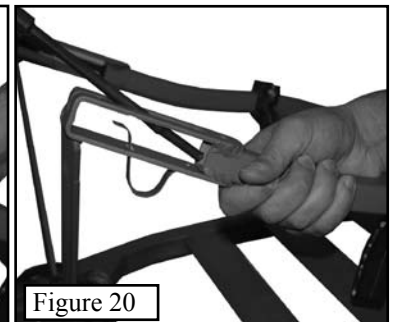

Figure 20

**WARNING:** Usually, the front edge of the treestand (the edge away from the tree) should be 4-6 inches higher than the edge against the tree (See **Figure 23**). The treestand seat climber attaches above the standing platform and should also have the same basic angle as the platform before you start to climb. **WARNING:** The standing platform and climber **MUST BE** attached to each other with the tether rope supplied, as shown in **Figure 24**. Wrap the rope around **TWICE** before tying it off.

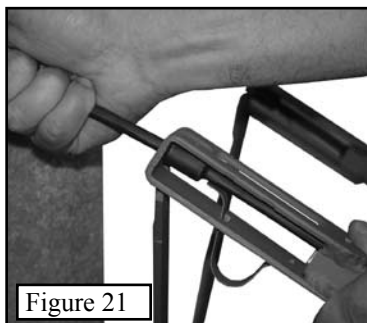

Figure 21

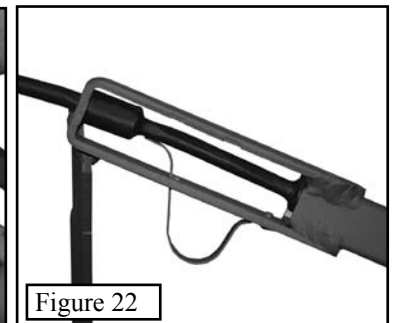

Figure 22

## Part 2. Climbing With Your New Stand.

**Step 1.** Now that your platform and seat section are attached to the tree, you are ready to climb. It is **MANDATORY** that you use a safety harness as you climb. **Be sure to read the safety harness instructions for proper use of your safety harness.** Simply attach the safety line to the tree above the seat climber and secure it to the harness for climbing as shown in **Figure 25**.

If you purchased a Razor SS, you must first position the climbing bar in order to sit on it and climb. Position the climbing bar so that the keyhole slot in the support strut will fit over the head of the bolt as shown in **Razor Figure A**. Now slide both support bars - at the same time - over the bolts and completely through the keyhole slots as shown in **Razor Figure B**. Now pull down on the climbing bar (as it is already attached the tree) to “seat” the bolts into the back of the support struts (See **Razor Figure C**). The climbing bar is now ready to use.

If you purchased either model Summit 180, you will climb with the seat facing towards the tree and you will sit in the seat - not on the front bar. The seat on the 180 models **DOES NOT** have a bungee cord attached to it. The seat has a sewn in webbing strap that can be wrapped around the front bar and snapped to secure it. This will hold the seat back up as you climb.

**Step 2.** Your RapidClimb stirrups and bungee heel cords should be already attached to your treestand. To climb, back your heel into the bungee heel cord (**Figure 26**) then simply slide your boot under the RapidClimb stirrup. Make sure that your boot is secure under the stirrup as shown in **Figure 27**. At this point **IT IS REQUIRED THAT YOU** attach your safety harness to the safety line around the tree. Hook the seat back elastic bungee cord as shown in **Figure 28** to keep it secure while you climb. NOTE: The Summit 180 models do not have a seat back bungee.

**Step 3.** To begin climbing, raise your seat climber up to just below waist height (Razor SS may require slightly higher position), re-engage the climber, sit on the padded bar (or seat with the Summit 180 models) and grasp the upright arms very firmly as shown in **Figure 29**.

**Step 4.** With all of your weight back on the padded bar, disengage the platform by lifting the treestand platform, as shown in **Figure 30**.

**Step 5.** To re-engage the platform, simply rotate the edge back against the tree upwards, as shown in **Figure 31**. **WARNING: DO NOT JUMP OR BOUNCE ON THE PLATFORM OR SEAT** to attempt to cause it to “dig” into the tree. It is not necessary and may cause you to inadvertently disengage the platform or seat.

**Step 6.** Now ease your weight back onto the platform (to ensure that you have not placed it on an unseen knot or limb on the backside of the tree), then slide your safety harness rope up the tree. **Repeat steps 3-6** until you are at your desired hunting height.

**WARNING: DO NOT TIP YOUR WEIGHT ONTO YOUR TOES** unless you are ready to move the platform. This will tend to disengage the platform from the tree. The RapidClimb stirrups are located in such a position that equal distribution of weight will secure the platform to the tree while climbing.

**WARNING: DO NOT USE** the Viper SS, Goliath SS, Razor SS or Summit 180 SS without a Viper SS, Goliath SS, Razor SS or Summit 180 SS seat or other climber. The climbers provided with these stands are designed to aid you in the correct operation of the treestand while climbing by keeping your weight away from the tree. The seat climber is also built so that it fits securely with the platform for carrying.

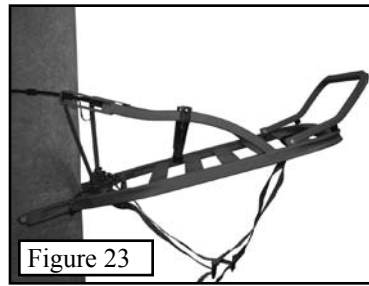

Figure 23

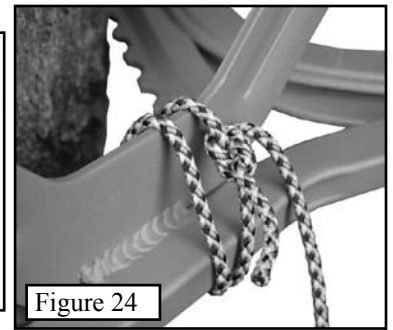

Figure 24

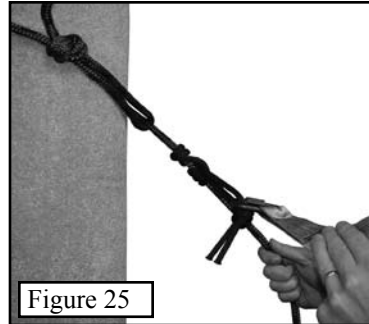
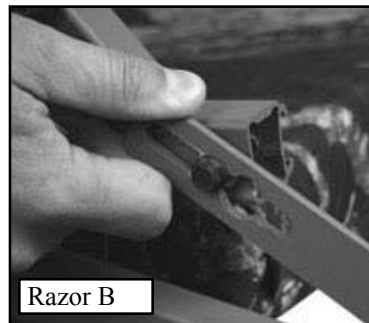

Figure 25



Razor A



Razor B



Razor C

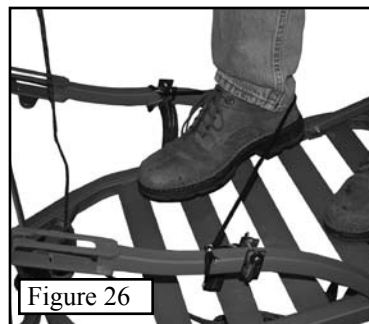

Figure 26



Figure 27



Figure 28



Figure 29

### Part 3. Using Your New Stand.

**WARNING: NEVER DISCONNECT FROM YOUR SAFETY LINE ONCE YOU ARE IN THE TREE!!**

**Step 1.** When you get to your hunting height (do not climb higher than 15 feet; it is unnecessary) and have assured that your treestand is level, position your seat climber slightly below waist level. Slightly lower will be more comfortable but higher makes for less movement when you stand.

**Step 2.** Wrap the supplied green tourniquet buckle strap (1" strap with spring loaded buckle) around the tree and through the seat frame as shown in **Figure 32**. Securely tighten the strap to prevent the notched teeth area from losing contact with the tree.

**Step 3.** Unhook the bungee cord that held the seat back rest secure while you were climbing. Position the seat back rest by wrapping each end of the bungee cord around the climbing cable and hooking the two hooks together as shown in **Figure 33**. The bungee cord will prevent the seat backrest from falling forwards if you stand up. On the Summit 180 model, hook the webbing strap that is sewn into the back of the seat around the frame to secure it. This will hold the seat back upright.

**Step 4.** With your safety harness attached to the tree above the climber, simply pull your feet, one at a time, from their secured position under the RapidClimb stirrups. **CAUTION:** If you purchased a Razor SS, **BEFORE HUNTING** you must first release the climbing bar from the climbing position. Simply reverse the steps by lifting slightly up on the bar, removing the support bars from the shoulder bolts, and carefully stepping over the bar as you swing it up and under the seat.

**Step 5.** Position your safety harness to minimize the amount of slack in the safety line and tether strap then carefully sit down. The treestand seat will provide maximum comfort when the seat pad is near horizontal rather than tipped down in the front. The seat height can be easily raised (for bow hunting) or lowered (for gun hunting) by adjusting the two piece buckles up or down the webbing. See **Figure 34**. **CAUTION:** The adjustments should be made on the ground. Both sides must be adjusted evenly so the seat is level side to side. Sliding the webbing straps forward or backward on the frame give additional comfort.

### Part 4. Climbing Down With Your New Stand.

**NOTE:** The Razor SS climbing bar must first be reconnected in the climbing position.

**Step 1.** Reattach your treestand platform to your feet - **KEEP YOUR HARNESS SECURELY ATTACHED TO THE TREE** until reaching the ground. **Follow the steps in Part 2, Step 2.**

**Step 2.** Disconnect the elastic cord that has been holding the foam seat in place and fold the seat up. Secure the backrest and seat as shown previously in **Figure 28**. Disconnect and store the strap that has held the seat frame to the tree (shown in previous **Figure 32**).

**Step 3.** Place the seat climber at about knee level, sit on the padded bar (or in the seat with the Summit 180), and grasp the upright arms as you did when climbing (see **Figure 35**).

**Step 4.** While firmly grasping the seat climber upright arms, disengage the platform by lifting up and tipping the edge closest to the tree downward. Once the platform has been dislodged, you can lower it down (see previous **Figure 30**). Make slow, even movements of 10-12 inches at a time.

**Step 5.** To re-engage, rotate the top edge of the treestand closest to the tree upwards. Now carefully place your weight back on the treestand. **WARNING: DO NOT JUMP OR BOUNCE ON THE PLATFORM OR SEAT** to attempt to cause it to "dig" into the tree. It is not necessary and may cause you to inadvertently disengage the platform or seat.

**Step 6.** Slide your safety harness rope down to about chest height and **repeat steps 3-6** until you have reached the bottom of the tree. **NEVER disconnect your harness until reaching the ground.**

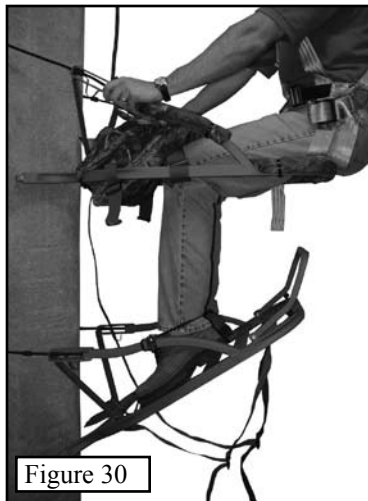

Figure 30



Figure 31

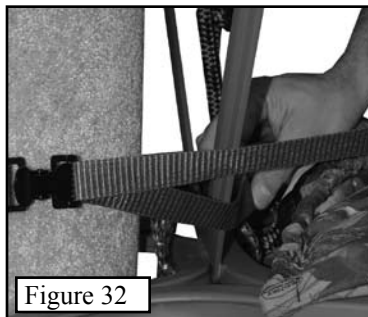

Figure 32

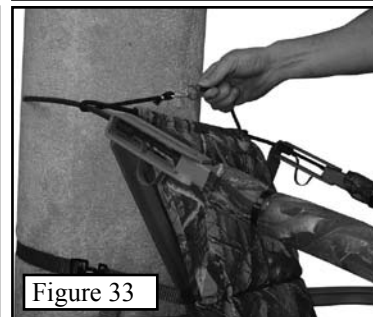

Figure 33

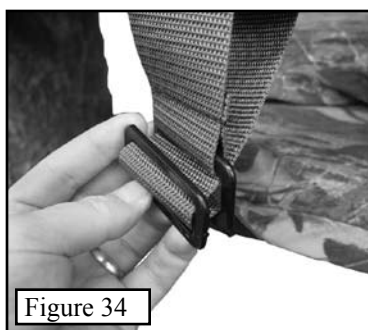

Figure 34



Figure 35

### Tips

You will easily learn how to use your Summit treestand more efficiently and make it more effective for your hunting.

With proper practice you can learn to level your platform without climbing down to re-position the cable. Pulling the cable against the backside of the tree while you're supporting the platform with your legs can do this. While the cable is against the tree, position the platform level and engage the front edge against the tree. This puts a slight bend in the cable while keeping the platform level. Only minor level adjustment, however, can be made using this technique. (The DVD shows this technique).

Sometimes on a cold, dry, hard bark tree a rubbing noise can be produced at the scalloped edge that engages the tree. This comes from friction forces. It can be eliminated a couple of ways. First, simply re-positioning your platform slightly will in most cases eliminate the noise. Second, a liquid or candle/bowstring wax can be applied at the intersection of the tree and the scalloped edge to reduce the friction. Also, using a file to remove the finish and slightly upset (roughen) the smooth metal surface contact points on the scallops can eliminate the noise.

Changing your sitting position can relieve muscle stress and reduce fatigue. This will allow a longer hunt and perhaps an opportunity for a shot. Although it must be done slowly and quietly, repositioning and changing the height of your seat by raising or lowering the seat frame just a couple of inches could make a difference. This changes the hip to knee angle. Moving the seat straps, again slowly and quietly, forward or backward on their support bar will alter the sitting position also. Being comfortable will result in no movement and reduce being detected by game either from sight or from sound.

### Part 5. Backpacking / Carrying Your New Treestand.

Your treestand is designed to “nest” together as one unit making it easy to transport.

**Step 1.** Start with the seat climber portion of the stand, set it on its end as shown in **Figure 36**. The Razor SS climbing bar must be in the up position - parallel to the stand frame as shown in **Figure 37**. Slide the arm pads down towards the cable bracket.

**Step 2.** Take the platform and slide it into the seat climber so that its upright braces and cable bracket are next to the same areas on the seat climber as shown in **Figure 38**.

**Step 3.** The teeth area on the platform should come into contact with the “V” brace on the seat climber. From this position, pull the seat backrest through the large gap in the platform as shown in **Figure 39**.

**Step 4.** Secure the seat to the stand by running the seat bungee around the frame and clipping it off. **Figure 40**.

**Step 5.** The backpack straps will most likely be wedged in behind the seat. Pull them out and around the seat webbing and push the seat as far down in the frame as possible (see **Figure 41**).

**Step 6.** Secure the top and platform together with the 1” wide green strap with the spring loaded tourniquet buckle as shown in **Figure 42**. This will prevent the seat and the platform from making noise as you hike to your hunting location.

**Step 7.** Use the backpack straps to carry the unit on your back as shown in **Figure 43**. Pull the loose end of the straps to tighten and pull up on the buckle to release.

### Section 3. Maintenance and Care of Your Treestand.

Because of the quality construction techniques used in manufacturing, your Summit Treestand is very durable under normal hunting conditions. However, since all hunting equipment that is exposed to the elements requires some maintenance and care, the following guidelines for caring for your treestand should be used. **DO NOT** leave your treestand outdoors when it is not being used. **Any tubing that is allowed to fill with rainwater and freeze WILL rupture or burst. DO NOT use your treestand if this happens.** If your treestand is exposed to the elements, it will be necessary to cover the seat to prevent rain and moisture from saturating the material. This will extend the life of the seat material as well as make it more comfortable the next time it is used.

The powder coat finish that is applied at the factory is very durable and should need touch ups only in areas of heavy wear or accidental impact.

Should you damage any part of your Summit Treestand, contact your nearest authorized Summit dealer or the factory to obtain the proper corrective action procedure and/or replacement parts for the treestand. Unauthorized repairs, modifications, or alterations will void the warranty and could degrade the integrity of the treestand. You must perform periodic inspections of the treestand for damage.

**WARNING: DO NOT use the treestand if ANY obvious or suspected damage is observed.** It is **VERY IMPORTANT** to inspect the cable on your climbing treestand to ensure that there is no sign of frayed, damaged or broken strands. If **ANY** such damage is noticed, you must replace your cable **IMMEDIATELY**. Replacement covering for the cables is also available. **NOTE:** The plastic covering on the cables serves **ONLY** as a noise reducer. Over time your cable cover will begin to wear. This is normal.

**CAUTION:** Look for nicks, gouges, cuts, cracks, bends, corrosion or similar damage that can be the result of improper use or accidental damage. For instance, this could occur if someone else used the treestand without knowledge of its proper use, or if the treestand were dropped,



Figure 36

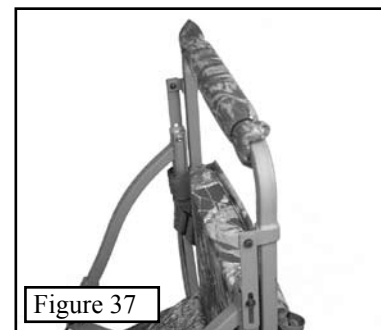

Figure 37



Figure 38



Figure 39



Figure 40



Figure 41



Figure 42



Figure 43

hit by a motor vehicle or subject to corrosive conditions, etc. Summit Treestands have the highest structural integrity by design, material selection and manufacturing techniques, but as its owner, only your continued care will assure trouble free performance. When the above-mentioned guidelines are followed, your Summit Treestand will provide years of successful hunting.

#### Section 4. Adjustments

The only adjustments that may be required on your Summit Treestand would be the RapidClimb Stirrups, backpack straps or seat height. The RapidClimb Stirrups should be adjusted before you go hunting. Put your hunting boots on and step into the stirrups with the treestand platform on a flat surface. Loosen the wing nut and slide the stirrups until they securely fit your boots, then re-tighten the wing nuts.

To loosen the backpack straps, simply pull up on the thumb tabs. To tighten them, pull down on the loose tag ends of the straps. This can be done before or after the treestand is on your back.

The seat height can be adjusted by means of the two piece buckle on each seat strap. This adjustment should be made on the ground and both sides must be adjusted equally so the seat is level side to side.

#### Harness Suspension

It is necessary and very important that someone knows your hunting location and time of return. It is also very important that you carry (on your person) emergency communication devices such as a cell phone, two-way radio, whistle, signal flare or preferably a PLD (Personal Locator Device - FCC approved July, '03). When triggered, a PLD will transmit an emergency signal to local rescue teams identifying your location via satellite GPS coordinates. Wilderness outfitters and the internet are sources for these PLD's.

Suspension trauma or blood pooling can occur when suspended motionless in a harness for periods of time. This can lead to unconsciousness. **WARNING: IF YOU HAVE TO HANG IN THE TREE BEFORE HELP ARRIVES, YOU NEED TO EXERCISE YOUR LEGS BY PUSHING OFF FROM THE TREE OR BY USING THE ENCLOSED SUSPENSION RELIEF STRAP. SEE THE TREESTAND HARNESS INSTRUCTIONS AND THE ENCLOSED INSTRUCTIONS FOR MORE INFORMATION.**

Self extraction may be necessary in the unfortunate situation that A) No one knows your location, B) Your communication efforts are exhausted, and C) You're confident that you have the strength, dexterity and ability to perform self-extraction and D) You decide this is your "absolute last resort". It is necessary to carry a device to assist with this self-extraction. Simple devices such as screw-in steps or a rope "Tree Descender" (available from Summit) will allow you to remove the weight from your harness. This may enable you to return to the treestand/ladder/climbing steps or slowly descend the tree.

Cut Along Line

Cut Along Line

#### Warranty Card for Summit Treestand

Treestand Purchased: Viper SS (PN 81066)  Ultimate Viper (PN 81072)  Goliath SS (PN 81067)  Razor SS (PN 81068)

Summit 180 SS (PN 81069)  Summit 180 SS Max (PN 81073)

Owners Name: \_\_\_\_\_ Street Address: \_\_\_\_\_

City: \_\_\_\_\_ State: \_\_\_\_\_ ZIP: \_\_\_\_\_ Phone: (\_\_\_\_) \_\_\_\_\_

Date Purchased: \_\_\_\_\_ Purchased From (Dealer Name): \_\_\_\_\_ Price \$: \_\_\_\_\_

Your heard about us through: Magazine  Advertisement  Video  Friend  Summit Catalog

Other  Please Explain: \_\_\_\_\_

You can also register your warranty card on line at: [www.summitstands.com/warranty.aspx](http://www.summitstands.com/warranty.aspx)

#### Limited Warranty

##### (A) Warranty

Summit Treestands, LLC (Summit) warrants to the original retail purchaser that all products manufactured by it are free from defects in material and manufacture at the time of shipment for sixty (60) months from the date of purchase. Summit will repair or replace any part found defective if the unit claimed to be defective shall be returned to Summit, postage prepaid, within the warranty period.

This warranty shall not apply to any product which has been subjected to misuse; misapplication; neglect (including but not limited to improper maintenance); accident; improper installation; modification (including but not limited to use of unauthorized parts or attachments); adjustment or repair. THE FOREGOING IS IN LIEU OF ALL OTHER WARRANTIES, WHETHER EXPRESS OR IMPLIED (INCLUDING THOSE OF MERCHANTABILITY AND FITNESS OF ANY PRODUCT FOR A PARTICULAR PURPOSE), AND OF ANY OTHER OBLIGATION OF LIABILITY ON THE PART OF THE COMPANY.

##### (B) Limitation of Liability

It is expressly understood that Summit's liability for its products, whether due to breach of warranty, negligence, strict liability, or otherwise, is limited to the repair of the product, as stated above, and Summit will not be liable for any other injury, loss, damage, or expense, whether direct or consequential, including but not limited to loss of use, income, profit, or damage to material, arising in connection with the sale, installation, use of, inability to use, or the repair or replacement of Summit's products.

Summit reserves the right to make alterations or modifications in its products at any time, which in its opinion, may improve the performance and efficiency of the product. It shall not be obligated to make such alterations or modifications to products already in service.

Please fill out the warranty card and return to:

**SUMMIT Treestands, LLC.  
715 Summit Dr.  
Decatur, AL 35601**

**Good Hunting and Hunt Safe!**

**HUNT TOMORROW...**

**...USE YOUR SAFETY HARNESS TODAY!**

©(STLLC 2007)

Summit products are manufactured under one or more of the following US Patents: 5,937,969; 5,971,104; 5,975,242; 5,979,603; 6,125,966; 6,182,792; 6,397,973; D,417,011; D,420,147

Summit Bucksteps and RapidClimb Stirrups are Patent Pending

**Parts List**

**BOX CONTENTS VIPER, GOLIATH, RAZOR, 180**  
**BOX CONTENTS VARY BY MODEL**

| PN    | DESCRIPTION                        | QTY |
|-------|------------------------------------|-----|
| 81062 | Platform                           | 1   |
| 81053 | Viper SS / Ultimate Top            | 1   |
| 81054 | Goliath SS Top                     | 1   |
| 81055 | 180 SS Top                         | 1   |
| 00000 | 180 SS Max Top                     | 1   |
| 40130 | Razor SS Climbing bar              | 1   |
| 85124 | Viper, Goliath, Razor Foam Seat    | 1   |
| 85117 | Ultimate Viper / 180 Max Foam Seat | 1   |
| 85071 | 180 Foam Seat                      | 1   |
| 30700 | Climbing Cable                     | 2   |
|       | Accessory Packet                   | 1   |

**ACCESSORY PACKET CONTENTS**

| PN    | DESCRIPTION                               | QTY |
|-------|---|-----|
| 74223 | 12" Arm Pad Viper models and Razor SS     | 2   |
| 74224 | 18" Bar Pad Razor SS                      | 1   |
| 74225 | 36" Front Pad Viper models                | 1   |
| 74226 | 72" Front Pad Goliath SS, 180 models      | 1   |
| 85051 | In-Line Cable Ties (Viper models)         | 8   |
|       | In-Line Cable Ties (Razor)                | 6   |
|       | In-Line Cable Ties (Goliath, 180 models)  | 7   |
| 83032 | Summit 4 Point Safety Harness             | 1   |
| 83023 | Safety Line with Prussic Hitch            | 1   |
| 10512 | Locking Clip for Safety Line / Harness    | 1   |
| 10953 | Suspension Relief Strap with Instructions | 1   |
| 85005 | Backpack straps (3 Pieces)                | 1   |
| 30536 | Umbilical Rope                            | 1   |
| 30285 | Tourniquet Strap with Buckle (green)      | 1   |
| 10534 | Stirrup                                   | 2   |
| 30341 | Stirrup Bungee with hook                  | 1   |
|       | 2007 DVD                                  | 1   |
|       | Written Treestand Instructions            |     |
|       | Written Instructions for Summit Harness   |     |
| 21070 | Stirrup Hardware Kit (excluding Razor SS) | 1   |
| 21068 | Razor Only Hardware Kit                   | 1   |
| 10466 | Razor Only Keyhole Bracket                | 2   |

**21070 STIRRUP HARDWARE KIT CONTENTS**

| PN    | DESCRIPTION         | QTY |
|-------|---------------------|-----|
| 10621 | 1 3/4" Bolt (10-24) | 2   |
| 10623 | Wing Nut (10-24)    | 2   |

**21068 HARDWARE KIT RAZOR SS MODEL ONLY**

| PN    | DESCRIPTION                     | QTY |
|-------|---------------------------------|-----|
| 10606 | 2" Bolt (1/4 x 20)              | 2   |
| 10612 | Centerlock Nut (1/4 x 20)       | 6   |
| 10640 | Long Shank Bushing              | 4   |
| 10641 | Short Shank Bushing             | 8   |
| 10688 | 15/16" Tall - Nylon Spacer      | 2   |
| 10689 | 1 3/4" Shoulder Bolt (1/4 x 20) | 2   |
| 10605 | 3/4" Bolt (1/4 x 20)            | 2   |
| 10693 | 1/4" Metal Bushing              | 2   |
| 10621 | 1 3/4" Stirrup Bolt (10-24)     | 2   |
| 10623 | Stirrup Wing Nut (10-24)        | 2   |

