

Trophy Chair

Instruction Booklet - 2008



SUMMIT
EST. 1981
TREESTANDS

You **MUST** also view the enclosed DVD **BEFORE** using your new treestand / climbing aid / ladder stand / pod stand!! If this DVD does not play in your DVD player - please contact us for a replacement.

Weight Limit 260 lbs. total. **DO NOT EXCEED THIS LIMIT!**
(Total weight includes person and all gear / clothing)

Tree Size: 8" - 30" Diameter

READ ME FIRST!!!

Please read carefully **BEFORE** using your new Summit Trophy Chair.

Congratulations! You have purchased the finest commercially available treestand on the market today. Summit Trophy Chair are designed and built to provide years of trouble-free, successful hunting with a minimum of maintenance and care. They are certified to meet the requirements of the Treestand Manufacturers Association (TMA) Standards. This booklet is provided to you to outline the recommended use, care and maintenance of your Summit Trophy Chair.

Please read and follow all general safety warnings and precautions listed on the next page!

WARNING: IF USING THIS PRODUCT ABOVE GROUND LEVEL YOU MUST USE AN APPROVED FOUR POINT FALL ARREST SYSTEM! (NOT INCLUDED)

Warning

Before each use of your Summit Treestand, ALWAYS inspect the treestand for any structural damage, cracks, cable wear or abrasion that may have occurred in transporting your treestand. DO NOT USE IF ANY DAMAGE IS FOUND! DO NOT leave your treestand outdoors when it is not being used. Any tubing that is allowed to fill with rainwater and freeze WILL rupture or burst. DO NOT use your treestand if this happens.

----- **MUST READ - GENERAL SAFETY WARNINGS AND PRECAUTIONS** -----

General Warnings and Precautions:

1. **When hunting from a treestand falls can occur any time after leaving the ground causing injury or death.**
2. Wear a fall arrest system (FAS) comprising a full body harness at all times after leaving the ground. You must stay connected at all times after leaving the ground while using climbing and hang-on treestands. Single safety belts and chest harnesses are no longer preferred and should never be used. If you are not wearing a full body harness that is protecting you from a fall, do not leave the ground.
3. Read and understand all of the manufacturer's Warnings and Instructions and use all safety devices provided by the manufacturer. Contact the manufacturer for any questions. Failure to do so could result in injury or death.
4. **Never** exceed the weight limit of a treestand.
5. **Never** use a treestand while taking drugs (even prescription drugs) or alcohol.
6. **Never** use a treestand during inclement weather such as rain, lightning, windstorms or icy conditions.
7. **Never** use a treestand when feeling ill, nauseous or dizzy.
8. **Never** use a treestand on a dead, leaning, diseased or loose barked tree or on a utility pole.
9. **Never** rely on a tree branch for support.
10. **Never** jump or bounce on a treestand/ladder stand/pod stand/climbing aid to seat it to the tree.
11. Pull up a bow, backpack, firearm or other equipment only after being secure in the treestand and a firearm must be pulled up with it unloaded, chamber open and muzzle down.
12. Inform someone of the hunting location, where the treestand will be located and the expected duration of the hunt.
13. A signal device such a mobile phone, radio, whistle, signal flare or personal locator device (PLD) must be on your person and readily available at all times.
14. Inspect the treestand and all safety devices each time before use and do not store a treestand outdoors when not in use.
15. **Never** modify your stand in any way by making repairs, replacing parts, or altering adding or attaching anything to it except if explicitly authorized by the manufacturer.
16. Practice installing, adjusting and using your treestand at ground level prior to using it at elevated positions.
17. Instructions (written and video) should be kept in a safe place and reviewed at least annually. It is the responsibility of the treestand owner to furnish the instructions to any person that who borrows or purchases the treestand.

Climbing Treestand Warnings and Precautions:

1. The initial angle of the platform/climber at ground level must allow for the decrease in tree diameter while ascending by tilting slightly upward.
2. For two-piece climbing treestands the tether connecting the top and the platform must be secure and at the proper length recommended by the manufacturer.
3. Platform level adjustments should not be made anywhere except at ground level (except for those special cases of products designed and intended to be safely adjusted by the manufacturer's instructions).
4. While climbing, adjustments to the harness attachment to the tree (tether/tree belt) should be frequent and coordinated with treestand movement to maintain the least amount of slack in the tether that will allow for climbing.
5. Familiarize yourself with the use of climbers by practicing at ground level before using in a hunting environment.

Non-Climbing/Fixed Position/Hang On Treestand Warnings and Precautions:

1. The use of a lineman's/climbing belt is required when installing a hang-on treestand to stabilize the user with the tree.
2. Correct tightening and adjustments of chains, cables, straps, etc. are critical to stable hang-on treestand installation. All treestand contact points must be in contact with the tree before you step onto your stand.
3. Practice the attachment of hang-on treestands at ground level before using in a hunting environment.
4. **Never** leave a treestand in a tree for more than two weeks since weather or animals could cause damage. Tree growth can also stress and damage straps and buckles.
5. Use a haul line to raise and lower the treestand. **Never** climb with anything on your back.
6. Climbing aids (stick ladders, sectional ladders, steps, etc.) must extend above the platform to allow the user to step down onto the platform. **Never** step up to your stand from a climbing aid.

Ladder/Pod Stand Warnings and Precautions:

1. Use at least three people to install and/or take down a ladder treestand.
2. The crisscross straps and stabilization devices must be attached before climbing to the platform.
3. When installing a ladder stand, always bounce on the first rung to set the ladder into the ground according to manufacturer's instructions before proceeding to climb any higher.
4. Check every ladder section connection every time you use the stand before you leave the ground. If ladder sections are separating, do not use the stand.
5. Check the ground under stand to make sure it is firm and level. Sloping ground or uneven surface (one side on a rock) can cause your ladder to tilt or shift off the tree as you climb.
6. Maintain three points of contact when climbing a ladder treestand.
7. Always lean forward as you climb and attach your harness to the tree before securing the platform to the tree and stepping onto the platform.

Fall Arrest System (Harness) Warnings and Precautions:

1. Read and understand the manufacturer's Warnings, expiration date and instructions on how to use and how to properly adjust the harness.
2. Practice the use of a full body harness at ground level in the presence of a responsible adult to experience the feeling of hanging suspended before using in a hunting environment.
3. The length of the harness tether must be minimized at all times. It should be adjusted so that it is above the head with no slack (snug) in the sitting position and you should have the minimum amount of slack possible when climbing.
4. **Never** allow the tether strap to get under your chin or around your neck.
5. If the hunting location is unknown by anyone and communication efforts are unsuccessful, you must have a personal plan for recovery/escape because prolonged suspension in a harness can be fatal. It is important to exercise the legs by pushing against the tree or doing other forms of continuous leg exercises to avoid blood pooling while being suspended. Hunters with varying degrees of physical fitness may require different plans to recover/escape the effects of prolonged suspension. Have a personal plan and practice it in the presence of a responsible adult before leaving the ground. No one escape/rescue plan will work for every hunter on every tree in every circumstance. Only you can determine the best recovery/escape plan for your hunting situation and you must have a recovery/escape plan for your situation before leaving the ground. A suspension relief device **must** be on your person and readily accessible while using a harness. This device will allow the user to relieve the load on the lower extremities if suspended in a harness to maintain circulation in the legs and prevent suspension trauma (blood pooling). Be sure to follow the manufacturers' directions on the safe use of any suspension relief device.
6. Hunt from the ground when self-recovery/escape ability is absent.
7. There is time to make a correct decision on what action to take if a fall occurs while wearing a full body harness. It is important to remember, "**DO NOT PANIC.**"

Climbing Aids/Stick Ladder Warnings and Precautions:

1. A full body harness with lineman's/climbing belt must be worn at all times while installing or removing any hang-on climbing aids.
2. Hang-on climbing aids must be placed on the tree at a height above the platform where the user can maintain a hand hold on the unit and step downwards onto the treestand. **Never** step up from a climbing device to get into your stand.
3. When using a climbing/lineman's belt to ascend the tree, the full body harness should be attached to the tree before stepping down onto the treestand.
4. Sectional ladders and steps should be spaced on the tree to insure each step is no more than 18 inches apart.
5. Check every stick ladder section connection every time you use the stick ladder before you leave the ground. If stick ladder sections are separating, do not use the stick ladder.

Section 1. Assembling your new Trophy Chair.

Please contact us at www.summitstands.com or 256-353-0634 to obtain any missing parts or if your DVD does not work.

Part 1. Trophy Chair Assembly

Step 1. Place two short shank bushings on the **outside** of the bracket on the Arm Support Assembly as shown in **Figure 1**.

Step 2. Place two short shank bushings on the **outside** of the middle bracket on the Seat Post as shown in **Figure 1**.

Step 3. Place two short shank bushings on the **outside** of the lower bracket on the Seat Post as shown in **Figure 1**.

Step 4. Position the Arm Support and Seat Post as shown in **Figure 2**. Secure with two 3/4" bolts and lock nuts. Wrench tighten.

Step 5. Position the Support rod as shown in **Figure 2**. Secure each side using one 3/4" bolt with lock nuts. **Do not overtighten as this connection is designed to pivot.** Seat Frame should slide and pivot. If it does not, slightly loosen bolt.

Step 7. Position seat then slide it down onto the Arm Support Bar as shown in **Figure 3**.

Step 8. Use two self tapping screws to secure the seat webbing to the Arm Support bar. Run the screws in from the side as shown in **Figure 4**. A powered screw driver works best for this step.

Step 9. Position the arm rest pads as shown in **Figure 5**. The cable ties for attaching the pads are "in-line" cable ties: Note the correct and incorrect ways of attaching. To attach - pull the cable ties snug, cut off the excess, and rotate the clasp to the underside of the pad. Use two cable ties per pad.

Step 10. Push the looped end of the cam buckle strap through the welded wire loop on the top of the Seat Post. Loop the strap and buckle back through the sewn loop to create a cinch knot as shown in **Figure 6**.

Part 2. Carrying your Trophy Chair

To carry the Trophy Chair, first fold it flat. Next, take the supplied green tourniquet buckle strap and wrap it around the frame to secure it as shown in **Figure 7**. Take the long cam buckle tree strap and bring it over your shoulder. Clip the double J-Hook into the Support Rod slide to secure as shown in **Figure 8**.

Section 2. Use of the Trophy Chair.

Step 1. Wrap the cam buckle strap around the tree and hook the double J-Hook into the seat frame as shown in **Figure 9**.

Step 2. Pull the free end of the strap until tight.

Step 3. Push down on the chair to seat it on the tree.

Step 4. Wrap the supplied green tourniquet buckle strap the frame and the tree to secure (See **Figure 10**).

Step 5. Secure the seat back to the tree by wrapping the bungee cord around the tree and clipping it to its self.

Section 3. Maintenance and Care of Your Treestand.

Because of the quality construction techniques used in manufacturing, your Summit Treestand is very durable under normal hunting conditions. However, since all hunting equipment that is exposed to the elements requires some maintenance and care, the following guidelines for caring for your treestand should be used. **DO NOT** leave your treestand outdoors when it is not being used. **Any tubing that is allowed to fill with rainwater and freeze WILL rupture or burst.**

DO NOT use your treestand if this happens. If your treestand is exposed to the elements, it will be necessary to cover the seat to prevent rain and moisture from saturating the material. This will extend the life of the seat material as well as make it more comfortable the next time it is used.

The powder coat finish that is applied at the factory is very durable and should need touch ups only in areas of heavy wear or accidental impact.

Should you damage any part of your Summit Treestand, contact your nearest authorized Summit dealer or the factory to obtain the proper corrective action procedure and/or replacement parts for the treestand. Unauthorized repairs, modifications, or alterations will void the warranty and could degrade the integrity of the treestand. You must perform periodic inspections of the treestand for damage. **WARNING: DO NOT use the treestand if ANY obvious or suspected damage is observed.**

CAUTION: Look for nicks, gouges, cuts, cracks, bends, corrosion or similar damage that can be the result of improper use or accidental damage. For instance, this could occur if someone else used the treestand without knowledge of its proper use, or if the treestand were dropped, hit by a motor vehicle or subject to corrosive conditions, etc. Summit Treestands have the highest structural integrity by design, material selection and manufacturing techniques, but as its owner, only your continued care will assure trouble free performance. When the above-mentioned guidelines are followed, your Summit Treestand will provide years of successful hunting.

Tips

You will easily learn how to use your Summit treestand more efficiently and make it more effective for your hunting.

Changing your sitting position can relieve muscle stress and reduce fatigue. This will allow a longer hunt and perhaps an opportunity for a shot. Although it must be done slowly and quietly, repositioning and changing the height of your seat by raising or lowering the seat frame just a couple of inches could make a difference. This changes the hip to knee angle. Moving the seat straps, again slowly and quietly, forward or backward on their support bar will alter the sitting position also. Being comfortable will result in no movement and reduce being detected by game either from sight or from sound.

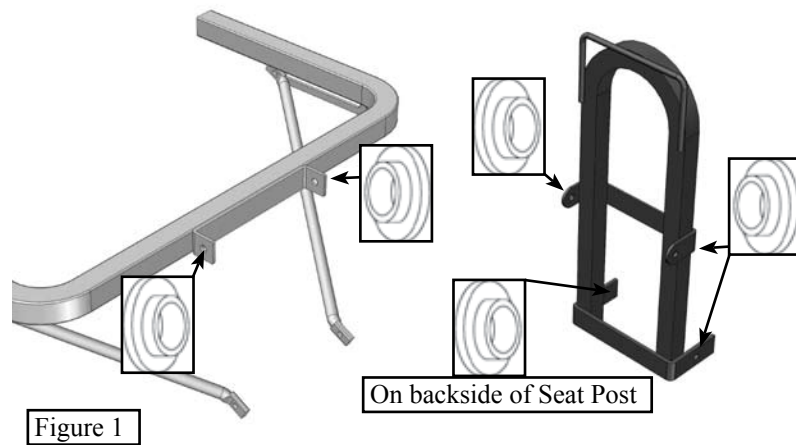

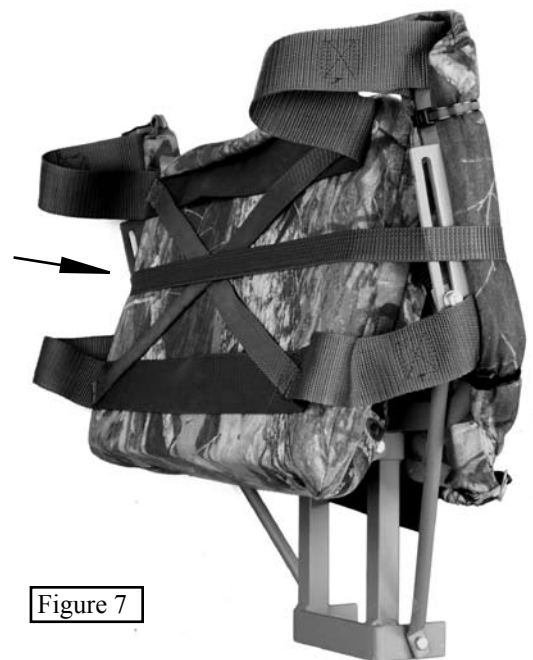
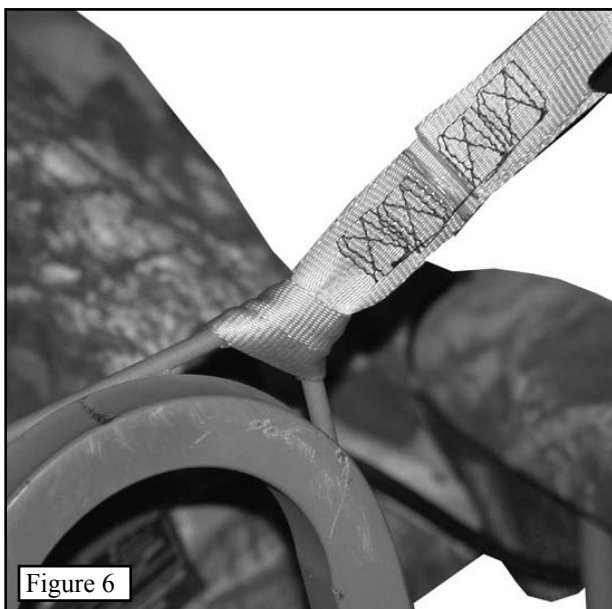
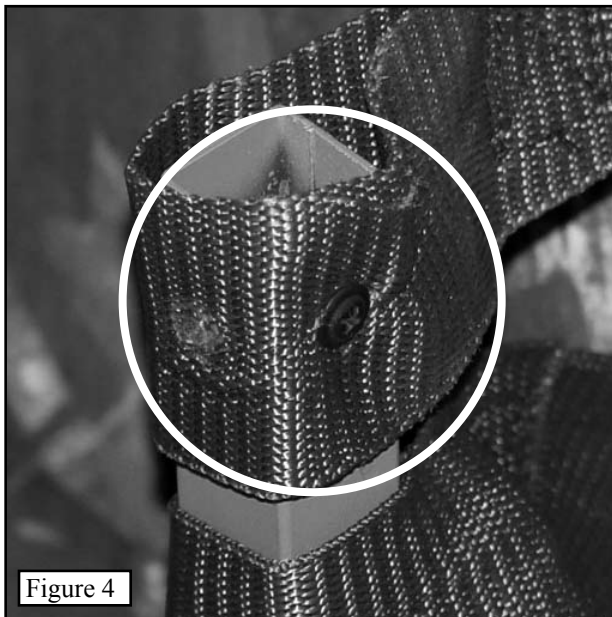
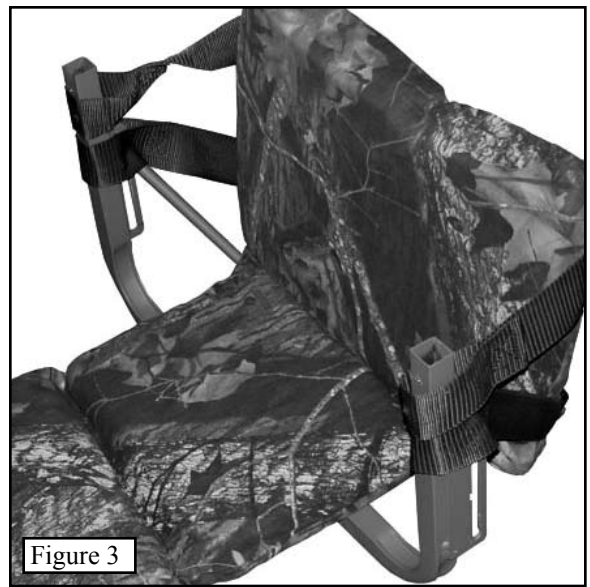
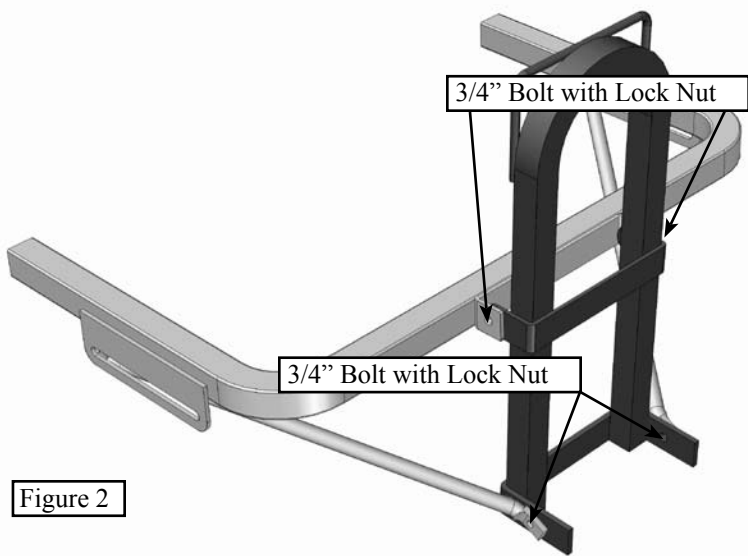



Figure 8



Figure 9

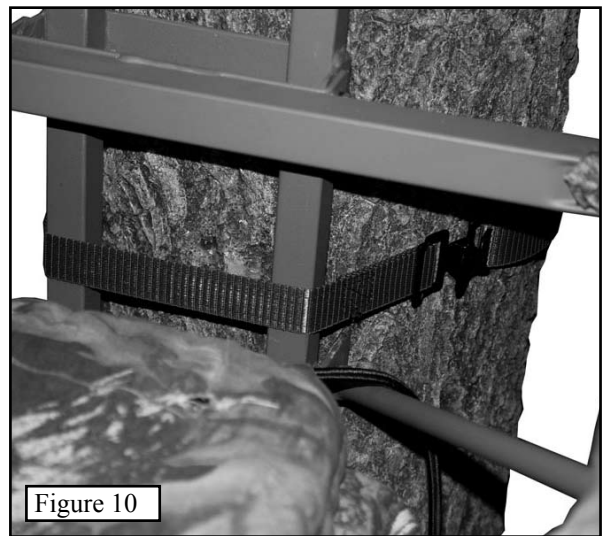

Figure 10

Limited Warranty

(A) Warranty

Summit Treestands, LLC (Summit) warrants to the original retail purchaser that all products manufactured by it are free from defects in material and manufacture at the time of shipment for sixty (60) months from the date of purchase. Summit will repair or replace any part found defective if the unit claimed to be defective shall be returned to Summit, postage prepaid, within the warranty period.

This warranty shall not apply to any product which has been subjected to misuse; misapplication; neglect (including but not limited to improper maintenance); accident; improper installation; modification (including but not limited to use of unauthorized parts or attachments); adjustment or repair. THE FOREGOING IS IN LIEU OF ALL OTHER WARRANTIES, WHETHER EXPRESS OR IMPLIED (INCLUDING THOSE OF MERCHANTABILITY AND FITNESS OF ANY PRODUCT FOR A PARTICULAR PURPOSE), AND OF ANY OTHER OBLIGATION OF LIABILITY ON THE PART OF THE COMPANY.

(B) Limitation of Liability

It is expressly understood that Summit's liability for its products, whether due to breach of warranty, negligence, strict liability, or otherwise, is limited to the repair of the product, as stated above, and Summit will not be liable for any other injury, loss, damage, or expense, whether direct or consequential, including but not limited to loss of use, income, profit, or damage to material, arising in connection with the sale, installation, use of, inability to use, or the repair or replacement of Summit's products.

Summit reserves the right to make alterations or modifications in its products at any time, which in its opinion, may improve the performance and efficiency of the product. It shall not be obligated to make such alterations or modifications to products already in service.

Please fill out the warranty card and return to:

SUMMIT Treestands, LLC.
715 Summit Dr.
Decatur, AL 35601

Parts List

BOX CONTENTS TROPHY CHAIR

PN	DESCRIPTION	QTY
10922	Trophy Chair Seat Post Assy.	1
71121	Trophy Chair Support Assy.	1
85037	Trophy Chair Foam Seat	1
72023	Trophy Chair Packet	1

72023 TROPHY SYSTEM ACCESSORY PACKET CONTENTS

PN	DESCRIPTION	QTY
74223	12" Arm Pad	2
85051	In-Line Cable ties	4
30325	Cam buckle strap	1
30285	Tourniquet Strap with Buckle (green)	1
	2007 Instructional DVD	1
	Written instructions for Trophy Chair Assembly	
22023	Hardware Packet	1

22023 HARDWARE PACKET CONTENTS

PN	DESCRIPTION	QTY
10641	Short Shank Bushing	6
10605	3/4" Bolt (1/4 -20)	4
10612	Centerlock Nut (1/4 -20)	4
10628	Self Tapping Screw	2

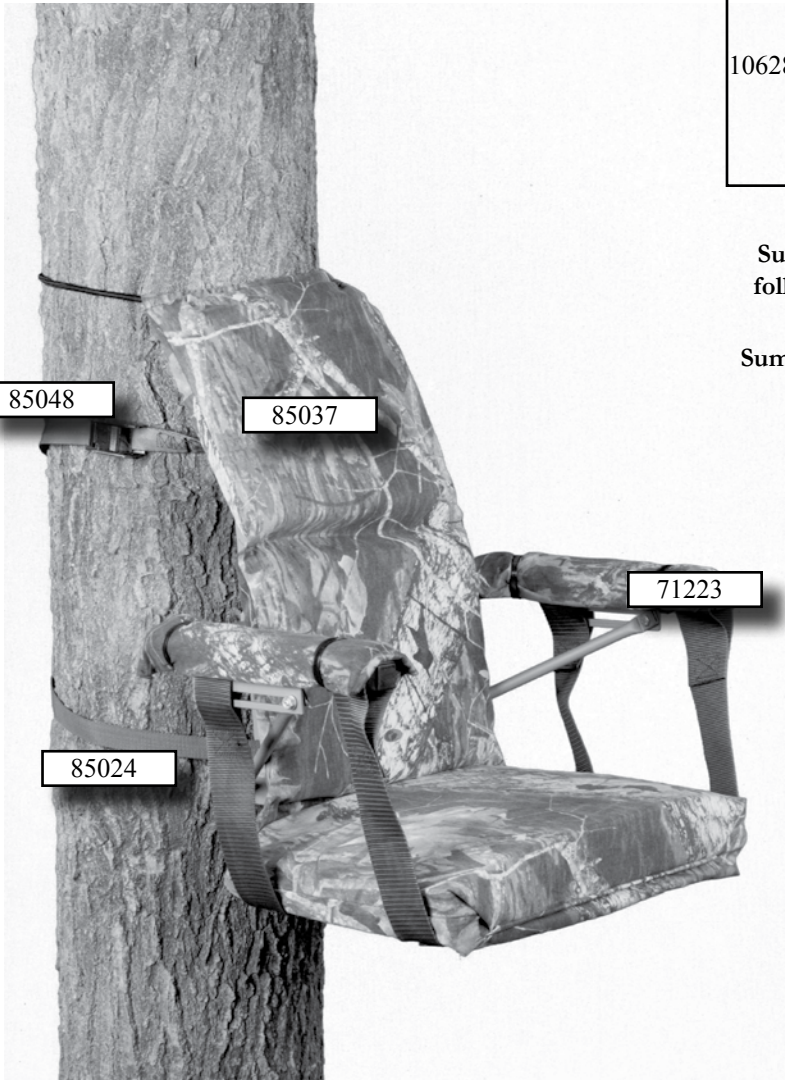

Summit products are manufactured under one or more of the following US Patents: 5,937,969; 5,971,104; 5,975,242; 5,979,603; 6,125,966; 6,182,792; 6,397,973; D,417,011; D,420,147

Summit Bucksteps and RapidClimb Stirrups are Patent Pending

**Visit us on the web at
www.summitstands.com
for accessories and
upgrades!**

Cut Along Line

Cut Along Line

Warranty Card for Summit Treestand

Treestand Purchased: Trophy Chair (PN 82023)

Owners Name: _____ Street Address: _____

City: _____ State: _____ ZIP: _____ Phone: (____) _____

Date Purchased: _____ Purchased From (Dealer Name): _____ Price \$: _____

Your heard about us through: Magazine Advertisement Video Friend Summit Catalog

Other Please Explain: _____

You can also register your warranty card on line at: www.summitstands.com/warranty.aspx