

INSTRUCTIONS

WARNING

You must fully read, understand and follow these warnings and instructions (written and video)! Failure to follow these instructions may cause serious injury or death!!

You **MUST** also view the enclosed DVD **BEFORE** using your new treestand!!

WEIGHT LIMITS

260 LBS. TOTAL*

DO NOT EXCEED THIS LIMIT!
(Includes all gear)*

Seat minimum and maximum
tree size: **8-30" diameter**

SUMMIT
EST. 1981
TREESTANDS

Summit Trophy Chair

PN 82061

- **WHEN HUNTING FROM A TREESTAND FALLS CAUSING INJURY OR DEATH CAN OCCUR ANY TIME AFTER LEAVING THE GROUND!** FOR THOSE REASONS ALWAYS WEAR A FALL ARREST SYSTEM (FAS) COMPRISING A FULL BODY HARNESS AT ALL TIMES AFTER LEAVING THE GROUND. YOU MUST STAY CONNECTED AT ALL TIMES AFTER LEAVING THE GROUND WHILE USING ANY ELEVATED HUNTING PLATFORM. SINGLE SAFETY BELTS AND CHEST HARNESSES ARE NO LONGER ALLOWED AND SHOULD NEVER BE USED. IF YOU ARE NOT WEARING A FULL BODY HARNESS THAT IS PROTECTING YOU FROM A FALL, DO NOT LEAVE THE GROUND!
- **ANYTIME THIS TREE SEAT IS USED IN CONJUNCTION WITH AN ELEVATED PLATFORM, SUCH AS THE SUMMIT BASIC SYSTEM, IT IS MANDATORY THAT:**
 - A LINEMAN'S BELT MUST BE USED DURING SETUP / TAKE DOWN (SOLD SEPARATELY).**
 - A 4 POINT FALL ARREST SYSTEM (FAS) MUST BE USED DURING USE (SOLD SEPARATELY).**
 - A PLATFORM AND LADDER MUST BE PURCHASED PRIOR TO USE (SOLD SEPARATELY).**
- READ AND UNDERSTAND ALL OF THE MANUFACTURER'S WARNINGS AND INSTRUCTIONS AND USE ALL SAFETY DEVICES PROVIDED. CONTACT SUMMIT TREESTANDS FOR ANY QUESTIONS. FAILURE TO DO SO COULD RESULT IN INJURY OR DEATH!
- A SIGNAL DEVICE SUCH A MOBILE PHONE, RADIO, WHISTLE, SIGNAL FLARE OR PERSONAL LOCATOR DEVICE (PLD) MUST BE ON YOUR PERSON AND READILY AVAILABLE AT ALL TIMES! ALWAYS INFORM SOMEONE OF YOUR HUNTING LOCATION, WHERE THE TREESTAND WILL BE LOCATED AND THE EXPECTED DURATION OF THE HUNT!
- DO NOT USE ANY TREESTAND UNLESS YOU ARE IN GOOD PHYSICAL SHAPE AND HAVE NO PHYSICAL LIMITATIONS OR MEDICAL CONDITIONS WHICH MAY PREVENT YOU FROM SAFELY USING THIS PRODUCT. ALWAYS CONSULT A PHYSICIAN IF YOU HAVE ANY QUESTIONS ABOUT YOUR PHYSICAL ABILITY TO USE THIS PRODUCT.
- NEVER USE A TREESTAND WHILE TAKING DRUGS, ALCOHOL OR CERTAIN PRESCRIPTION DRUGS! ALWAYS CONSULT A PHYSICIAN IF YOU HAVE ANY QUESTION ABOUT TAKING SPECIFIC MEDICATIONS AND USING THIS PRODUCT!
- NEVER USE A TREESTAND DURING INCLEMENT WEATHER SUCH AS RAIN, LIGHTNING, WINDSTORMS OR ICY CONDITIONS! END YOUR HUNT AND RETURN TO THE GROUND IF ANY OF THESE INCLEMENT CONDITIONS ARISE.
- NEVER USE A TREESTAND WHEN FEELING ILL, NAUSEOUS, DROWSY OR DIZZY!
- BE WELL RESTED AND NEVER HURRY. HURRYING CAUSES ACCIDENTS!
- NEVER USE A TREESTAND ON A DEAD, LEANING, DISEASED, LOOSE BARKED TREE, ON A UTILITY POLE OR ON TREES THAT HAVE ANY OBSTRUCTIONS THAT MAY LIMIT TREESTAND USE! NEVER RELY ON A TREE BRANCH FOR SUPPORT!
- NEVER JUMP OR BOUNCE ON A TREESTAND TO SECURE IT TO THE TREE!
- PULL UP A BOW, BACKPACK, FIREARM OR OTHER EQUIPMENT ONLY AFTER BEING SECURE IN THE TREESTAND. FIREARMS MUST BE PULLED UP UNLOADED, CHAMBER OPEN AND MUZZLE DOWN! NEVER CLIMB WITH ANYTHING ON YOUR BACK.
- NEVER MODIFY YOUR STAND IN ANY WAY BY MAKING REPAIRS, REPLACING PARTS, OR ALTERING, ADDING OR ATTACHING ANYTHING TO IT EXCEPT IF EXPLICITLY AUTHORIZED IN WRITING BY THE MANUFACTURER!
- PRACTICE INSTALLING, ADJUSTING AND USING YOUR TREESTAND AND HARNESS AT GROUND LEVEL, IN THE PRESENCE OF A RESPONSIBLE ADULT, LEVEL PRIOR TO USING IT AT ELEVATED POSITIONS!
- INSTRUCTIONS (WRITTEN AND VIDEO) SHOULD BE KEPT IN A SAFE PLACE AND REVIEWED AT LEAST ANNUALLY. IT IS THE RESPONSIBILITY OF THE TREESTAND OWNER TO FURNISH THE COMPLETE INSTRUCTIONS TO ANY PERSON WHO BORROWS OR PURCHASES THE TREESTAND! THIS SUMMIT TREESTAND IS DESIGNED TO BE USED AS A COMPLETE SYSTEM - NEVER LOAN OR SELL ONLY A PORTION OF THE HANG-ON TREESTAND SYSTEM.
- ALWAYS INSPECT THE STAND / CABLE SYSTEM OR HANGING STRAPS AND ANY SAFETY GEAR BEFORE EACH USE! IF ANY PROBLEMS ARE FOUND - DO NOT USE THE STAND! CONTACT CUSTOMER SERVICE FOR THE APPROPRIATE REPAIR / REPLACEMENT PROCEDURE!
- DO NOT LEAVE YOUR TREESTAND OUTDOORS OR STORE IT OUTDOORS WHEN IT IS NOT BEING USED! ANY STAND TUBING THAT IS ALLOWED TO FILL WITH RAINWATER AND FREEZE WILL RUPTURE OR BURST - DO NOT USE YOUR TREESTAND IF THIS OCCURS!

FORM# 18012, 3/2010

1 INDEX

GENERAL WARNINGS AND PRECAUTIONS, STAND WEIGHT LIMITS
 SECTION 1 - INDEX
 SECTION 2 - PARTS LIST
 SECTION 3 - TOOLS REQUIRED
 SECTION 4 - ASSEMBLY
 SECTION 5 - INSTALLATION AND USE
 SECTION 6 - USE WITH AN ELEVATED PLATFORM
 SECTION 7 - MAINTENANCE AND CARE
 SECTION 8 - HARNESS SUSPENSION
 SECTION 9 - LIMITED WARRANTY

PG 1
 PG 2
 PG 2
 PG 2
 PG 2 - 3
 PG 4
 PG 5
 PG 5
 PG 6
 PG 6

2 PARTS LIST

Please call 256-353-0634 or visit <http://www.summitstands.com/contactus/> if you have any questions, if you need replacement parts, if you have any missing parts or if the included DVD does not play.

TROPHY CHAIR BOX CONTENTS

PN	DESCRIPTION	QTY
10922	SEAT POST ASSEMBLY	1
10923	ARM SUPPORT ASSEMBLY	1
10924	SUPPORT TUBE	2
70276	FOAM SEAT	1
72023	ACCESSORY PACKET	1

22023 - HARDWARE PACKET CONTENTS

PN	DESCRIPTION	QTY
10641	SHORT SHANK BUSHING	6
10605	3/4" BOLT (1/4 x 20)	6
10612	LOCK NUT (1/4 x 20)	6
10628	SELF TAPPING SCREW	2
10625	WASHER	2
10627	METAL BUSHING	2

22023 - ACCESSORY PACKET CONTENTS

PN	DESCRIPTION	QTY
22023	HARDWARE PACKET	1
	12" FOAM ARM PAD	2
10656	IN-LINE CABLE TIES	4
30325	CAM BUCKLE TREE STRAP	1
30285	TOURNIQUET BUCKLE STRAP (GREEN)	1
	INSTRUCTIONAL DVD	1
	WRITTEN INSTRUCTIONS	1

3 TOOLS REQUIRED

Tools

- 7/16" Wrench / Socket with Ratchet
- Phillip's Head Screw Driver
- Knife or snips

Use

- Bolts
- Self Tapping Screws
- In-Line Cable Tie trimming

4 ASSEMBLY

1. Position one Support Tube as shown in **figure 1**.
2. Assemble the Support Tube by sliding it up against the Arm Support as shown in **figure 2**. Insert one, 3/4" bolt from the outside through the METAL bushing as shown. Place a Washer between the inside of the Arm Support and the Support Tube. Secure with one lock nut. Do not overtighten this connection as it is designed to slide backwards and forwards through the slot in the Arm Support.

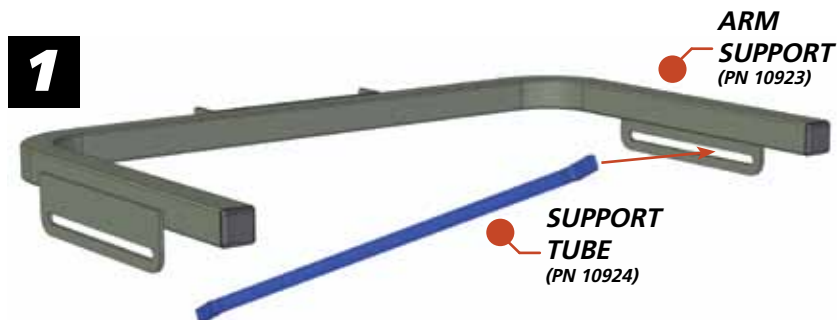

ASSEMBLY (continued)

3. Repeat for the other side.
4. Place two short shank bushings on the **outside** of the bracket on the Arm Support Assembly as shown in **figure 3**.
5. Place two short shank bushings on the **outside** of the middle and lower bracket on the Seat Post as shown in **figure 4**.
6. Place the remaining two short shank bushings on the **outside** of the middle and lower bracket on the Seat Post as shown in **figure 5**.
6. Position the Arm Support and Seat Post as shown in **figure 6**.
7. Secure each lower hole using one 3/4" bolt with lock nut per side (**see figure 7**). Do not overtighten as this connection is designed to pivot.
8. Secure each upper hole using one 3/4" bolt with lock nut per side (**see figure 8**). Do not overtighten as this connection is designed to pivot.

The Seat Frame should slide and pivot. If it does not, loosen these bolts slightly.

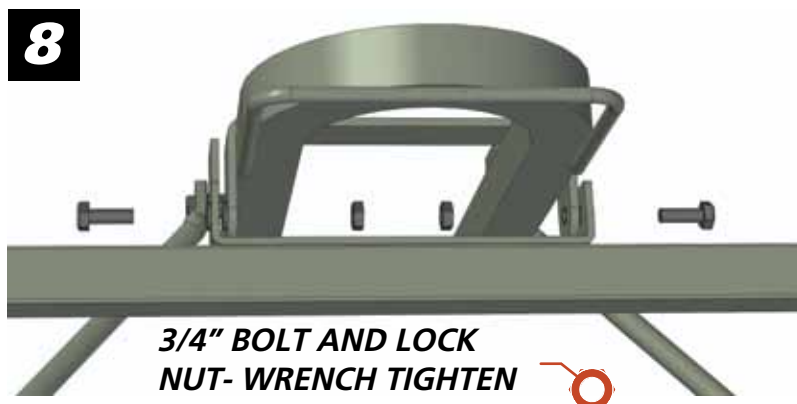
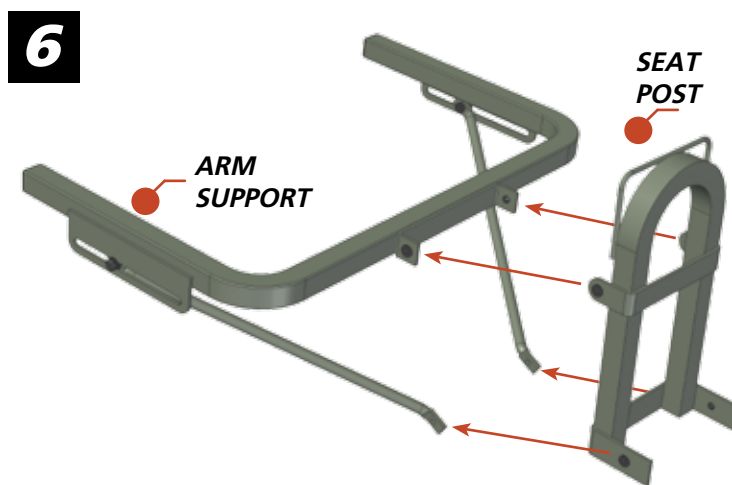
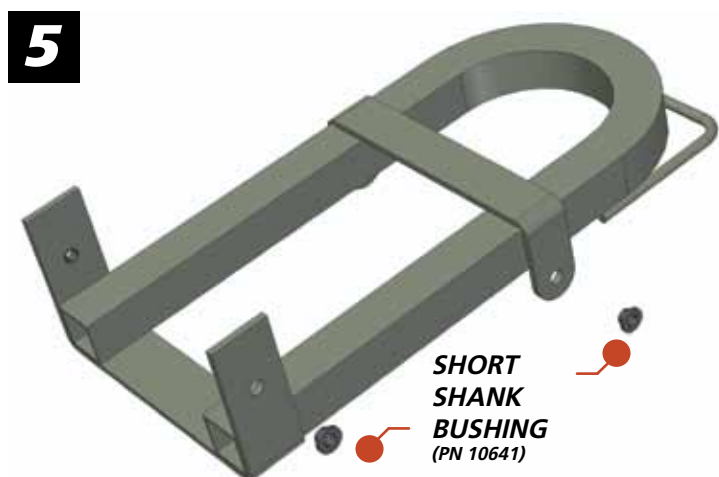
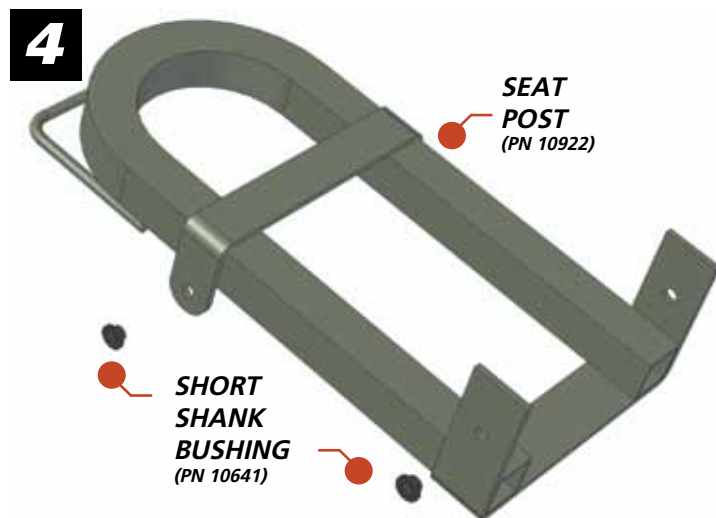
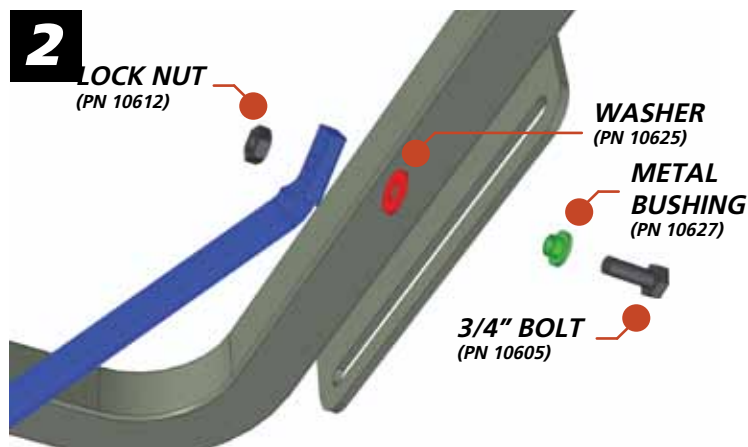

ASSEMBLY (continued)

9. Slide the seat down onto the Arm Support Bar as shown in **figure 9**.

10. Use two self tapping screws to secure the seat webbing to the Arm Support bar. Run the screws in from the side as shown in **figure 10**. A powered screw driver works best for this step.

11. Position the arm rest pads as shown in **figure 11**. The cable ties for attaching the pads are "in-line" cable ties: Note the correct and incorrect ways of attaching. To attach - pull the cable ties snug, cut off the excess, and rotate the clasp to the underside of the pad. Use two cable ties per pad.

12. Push the looped end of the cam buckle strap through the welded wire loop on the top of the Seat Post. Loop the strap and buckle back through the sewn loop to create a cinch knot as shown in **figure 12**.

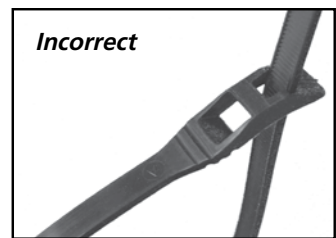
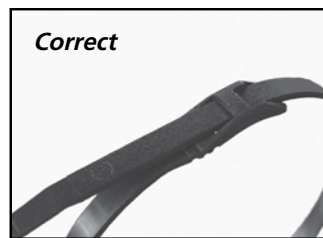

5 INSTALLATION AND USE

CARRYING YOUR TROPHY CHAIR

To carry the Trophy Chair, first fold it flat. Next, take the supplied green tourniquet buckle strap and wrap it around the frame to secure it as shown in **figure 13**. Take the long cam buckle tree strap and bring it over your shoulder. Clip the double J-Hook into the Support Rod slide to secure as shown in **figure 14**.



13



14

ATTACHING TO A TREE

1. Wrap the cam buckle strap around the tree and hook the double J-Hook into the seat frame as shown in **figure 15**.

2. Pull the free end of the strap until tight.

3. Push down on the chair to seat it on the tree.

4. Wrap the supplied green tourniquet buckle strap the frame and the tree to secure (**See figure 16**).

5. Secure the seat back to the tree by wrapping the bungee cord around the tree and clipping it to its self.



⚠ WARNING

Correct tightening and adjustment of the two attachment straps is critical. All frame contact points must be in contact with the tree before use.

6 USE WITH AN ELEVATED PLATFORM

⚠ WARNING

The use of a lineman's style climbing belt / rope is mandatory when installing or climbing into a hang-on treestand. **NEVER** attempt to install or climb into a hang-on treestand without being stabilized by a lineman's style climbing belt.

⚠ WARNING

ALWAYS use a pull up rope to raise and lower the trophy chair. **NEVER** climb with anything on your back.

⚠ WARNING

Climbing aids (Stick Ladders, Sectional Ladders, Steps, etc...) **MUST EXTEND ABOVE** the final position of the platform used with this product. **ALWAYS** step down from the climbing aid onto your platform. **NEVER** attempt to climb up onto a platform from a climbing aid mounted below the platform.

⚠ WARNING

YOU MUST be wearing a 4 point harness and lineman's climbing belt before attempting to install or climb into this tree seat if used from an elevated position. **Read and understand** all manufacturer's warnings, expiration date and instructions on how to use and properly adjust your harness.

⚠ WARNING

NEVER rely on a tree branch for support while climbing into or out of a suspended platform.

⚠ WARNING

NEVER use screw in steps as they can damage the tree and can be hazardous if you slip.

INSTALLATION

1. Following all manufacturer's warnings and instructions, mount your climbing aids to the tree - **ALWAYS** use a lineman's style belt when setting up or taking down climbing aids.
2. Following all manufacturer's warnings and instructions, mount your platform to the tree - **ALWAYS** use a lineman's style belt when setting up or taking down a hang-on platform. **ALWAYS** use a pull-up rope - never climb with anything on your back.
3. Using a pull-up rope, bring the Trophy Chair up to the desired height.
4. Follow the directions in **Section 5 ATTACHING TO A TREE** to attach the Trophy Chair to the tree.

⚠ WARNING

ALWAYS position your safety harness above your head so that the tether length is minimized at all times.

7 MAINTENANCE AND CARE

We recommend that your Trophy Chair be removed and stored in a dry place when not in use.

The powder coat finish applied at the factory is very durable and should only need touch ups in areas of heavy wear or accidental impact.

Should you damage any part of your Summit Treestand, contact your nearest authorized Summit dealer or the factory to obtain the proper corrective action procedure and/or replacement parts for the treestand.

⚠ CAUTION

Look for nicks, gouges, cuts, cracks, bends, corrosion or similar damage that can be the result of improper use or accidental damage. For instance, this could occur if someone else used the treestand without knowledge of its proper use, or if the treestand were dropped, hit by a motor vehicle or subject to corrosive conditions, etc.

Summit Treestands have the highest structural integrity by design, material selection and manufacturing techniques, but as its owner, only your continued care will assure trouble free performance. When the above-mentioned guidelines are followed, your Summit Treestand will provide years of successful hunting.

⚠ CAUTION

NEVER leave a hang-on treestand in a tree for more than two weeks at a time. Weather, animals and tree growth can damage the stand, attachment straps and buckles.

8 HARNESS SUSPENSION

It is necessary and very important that someone knows your hunting location and time of return. It is also very important that you carry (on your person) emergency communication devices such as a cell phone, two-way radio, whistle, signal flare or preferably a PLD (Personal Locator Device - FCC approved July, '03). When triggered, a PLD will transmit an emergency signal to local rescue teams identifying your location via satellite GPS coordinates. PLD's may be purchased at Wilderness outfitters or on the internet.

Suspension trauma or blood pooling can occur when suspended motionless in a harness for periods of time. This can lead to unconsciousness and death. If a suspension relief strap is furnished with your harness. Read your harness instructions to assure that you know how to use it. A suspension relief strap device must be on your person and readily accessible while using any harness.

⚠ WARNING

If you have to hang in the tree before help arrives, you need to exercise your legs by pushing off from the tree or by using the enclosed suspension relief strap. See the treestand harness instructions and the enclosed instructions for more information.

Self extraction may be necessary in the unfortunate situation that (A) no one knows your location, (B) your communication efforts are exhausted, (C) you are confident that you have the strength, dexterity and ability to perform self-extraction and (D) you decide this is your "absolute last resort". It is recommended to carry a device to assist with this self-extraction. Simple devices such as screw-in steps or a rope "Tree Descender" (available from Summit) will allow you to remove the weight from your harness. This may enable you to return to the treestand/ladder/climbing steps or slowly descend the tree.

Several optional products/systems are available that offer self-recovery or self extraction from a fall when suspended in a harness. Returning to the ground obviously also relieves suspension trauma and some systems automatically descend the user while others allow user control. If one of these products/systems is selected for use as an additional safety precaution against prolonged suspension, be sure to follow the manufacturers' directions for safe use.

9 WARRANTY

(A) Warranty

Summit Treestands, LLC (Summit) warrants to the original retail purchaser that all products manufactured by it are free from defects in material and manufacture at the time of shipment for sixty (60) months from the date of purchase. Summit will repair or replace any part found defective if the unit claimed to be defective shall be returned to Summit, postage prepaid, within the warranty period.

This warranty shall not apply to any product which has been subjected to misuse; misapplication; neglect (including but not limited to improper maintenance); accident; improper installation; modification (including but not limited to use of unauthorized parts or attachments); adjustment or repair. THE FOREGOING IS IN LIEU OF ALL OTHER WARRANTIES, WHETHER EXPRESS OR IMPLIED (INCLUDING THOSE OF MERCHANTABILITY AND FITNESS OF ANY PRODUCT FOR A PARTICULAR PURPOSE), AND OF ANY OTHER OBLIGATION OF LIABILITY ON THE PART OF THE COMPANY.

(B) Limitation of Liability

It is expressly understood that Summit's liability for its products, whether due to breach of warranty, negligence, strict liability, or otherwise, is limited to the repair of the product, as stated above, and Summit will not be liable for any other injury, loss, damage, or expense, whether direct or consequential, including but not limited to loss of use, income, profit, or damage to material, arising in connection with the sale, installation, use of, inability to use, or the repair or replacement of Summit's products.

Summit reserves the right to make alterations or modifications in its products at any time, which in its opinion, may improve the performance and efficiency of the product. It shall not be obligated to make such alterations or modifications to products already in service.

Please take the time to fill out the warranty card online at <http://www.summitstands.com/warranty> or fill out and mail in the enclosed warranty card.

www.summitstands.com
www.mysummitgear.com

Summit products are manufactured under one or more of the following US Patents: 5,937,969; 5,971,104; 5,975,242; 5,979,603; 6,125,966; 6,182,792; 6,397,973; D,417,011; D,420,147; D,575,411

Summit Bucksteps are Patent Pending

