

Basic, Comfort and Trophy System Instruction Booklet - 2006

You **MUST** also view the enclosed DVD **BEFORE** using your new treestand!!
Weight Limit 260 total. Tree Size: 8" - 20" - all models.

READ ME FIRST!!!

Please read carefully **BEFORE** using your new Summit Hang-On Treestand.

Congratulations! You have purchased the finest commercially available treestand on the market today. Summit Hang-On Treestands are designed and built to provide years of trouble-free, successful hunting with a minimum of maintenance and care. They are certified to meet the requirements of the Treestand Manufacturers Association (TMA) Standards. This booklet is provided to you to outline the recommended use, care and maintenance of your Summit Hang-On Treestand.

Warnings and Precautions

- **YOU MUST FULLY READ, UNDERSTAND AND FOLLOW THESE INSTRUCTIONS!**
- **YOU MUST USE A LINEMAN'S STYLE CLIMBING BELT TO INSTALL THIS TREE STAND. NEVER DISCONNECT FROM YOUR LINEMAN'S BELT UNTIL YOU ARE HOOKED INTO YOUR SAFETY LINE!**
- **DO NOT USE THIS OR ANY OTHER TREESTAND IF YOU HAVE BEEN USING DRUGS OR ALCOHOL OR ARE PHYSICALLY IMPAIRED IN ANY WAY!**
- **FOR YOUR SAFETY, DO NOT USE ANY TREESTAND DURING STORMS, WHEN TREES ARE WET OR ICY, OR ON TREES THAT ARE LEANING OR THAT APPEAR DEAD OR DISEASED!**
- **DO NOT USE ANY TREESTAND IF YOU HAVE NOT FOLLOWED THE MANUFACTURERS CARE AND MAINTENANCE GUIDELINES!**
- **NEVER ALLOW THE SAFETY HARNESS TETHER TO GET UNDER OR AROUND YOUR NECK!**
- **IT IS IMPORTANT THAT YOU REMEMBER TO BE PREPARED IF YOU HAPPEN TO FALL AND EMPLOY YOUR SAFETY HARNESS WHILE IN A TREESTAND. STAY CALM AND DO NOT PANIC. YOU MUST BE PREPARED TO RECOVER FROM YOUR FALL BY EITHER CLIMBING BACK ONTO YOUR TREESTAND OR USING A DEVICE SUCH AS THE "TREE DESCENDER" (AVAILABLE FROM SUMMIT, WWW.SUMMITSTANDS.COM, 256-353-0634). PRIOR TO HUNTING: YOU MUST NOTIFY SOMEONE OF YOUR HUNTING LOCATION AND WHEN YOU WILL RETURN!**
- **DO NOT USE ANY TREESTAND UNLESS YOU ARE IN GOOD PHYSICAL SHAPE. THE ABILITY TO DO SEVERAL PUSH-UPS, CHIN-UPS, SIT-UPS, ETC. IS REQUIRED FOR YOUR SAFETY!**
- **ALWAYS USE A HAUL LINE TO RAISE AND LOWER UNLOADED FIREARMS AND BOWS!**
- **NEVER CLIMB WITH ANYTHING IN YOUR HANDS OR ON YOUR BACK - USE A HAUL LINE!**
- **PRACTICE USING YOUR TREESTAND AND SAFETY HARNESS AT A LOW LEVEL (5 FEET) UNTIL YOU MASTER ITS USE.**
- **BE WELL RESTED AND NEVER GET IN A HURRY. HURRYING CAUSES ACCIDENTS!!**
- **IF YOU LOAN OR SELL THIS TREESTAND, IT IS YOUR RESPONSIBILITY TO FURNISH THE BUYER A COPY OF THESE INSTRUCTIONS AND THE VIDEO THAT CAME WITH THE TREESTAND. MAKE SURE THEY WATCH THE VIDEO AND READ / UNDERSTAND THE INSTRUCTIONS!**
- **FAILURE TO FOLLOW THESE INSTRUCTIONS MAY CAUSE SERIOUS INJURY OR DEATH!!**

Warning

Before each use of your Summit Treestand, **ALWAYS** inspect the treestand for any structural damage, cracks, cable wear or abrasion that may have occurred in transporting your treestand. **DO NOT USE IF ANY DAMAGE IS FOUND!** **DO NOT** leave your treestand outdoors when it is not being used. **Any tubing that is allowed to fill with rainwater and freeze WILL rupture or burst. DO NOT use your treestand if this happens.**

Section 1. Assembling your new Treestand

Part 1. Platform Assembly (All Models).

Step 1. Place two short shank bushings on the **outside** of each U-Bracket welded to the bottom of the platform (See **Figure 1**).

Step 2. Place two long shank bushings into the pre-punched holes in the end of the V-shaped Platform Leveler Bar (See **Figure 1**). Repeat for other side.

Step 3. Position the platform leveler into the U-Brackets and line up the holes. Secure with two 1 3/4" bolts and lock nuts as shown in **Figure 2**. **Note the correct orientation of the Leveler Bar.** The flat edge should face up as shown in the circle.

Part 2. Comfort System Seat Assembly

Step 1. Place two short shank bushings on the **inside** of the L-Shaped bracket on the Platform as shown in **Figure 3**.

Step 2. Place two long shank bushings into the pre-punched holes in the end of the seat tubing as shown in **Figure 3**.

Step 3. Position each end of the seat tube to the outside of the L-Shaped brackets and secure using two 1 1/2" bolts with lock nuts (See **Figure 4**).

Part 3. Trophy Chair Assembly

Step 1. Place two short shank bushings on the outside of the bracket on the Arm Support Assembly as shown in **Figure 5**.

Step 2. Place two short shank bushings on the outside of the middle bracket on the Seat Post as shown in **Figure 5**.

Step 3. Place two short shank bushings on the outside of the lower bracket on the Seat Post as shown in **Figure 5**.

Step 4. Position the Arm Support and Seat Post as shown in **Figure 6**. Secure with two 3/4" bolts and lock nuts. Wrench tighten.

Step 5. Position the Support rod as shown in **Figure 6**. Secure each side using one 3/4" bolt with lock nuts. **Do not overtighten as this connection is designed to pivot.** Seat Frame should slide and pivot. If it does not, slightly loosen bolt.

Step 7. Position seat then slide it down onto the Arm Support Bar as shown in **Figure 7**.

Step 8. Use two self tapping screws to secure the seat webbing to the Arm Support bar. Run the screws in through the webbing from the side as shown in **Figure 8**. A powered screw driver works best for this step.

Step 9. Position the arm rest pads as shown in **Figure 9**. The cable ties for attaching the pads are "in-line" cable ties: Note the correct and incorrect ways of attaching. To attach - pull the cable ties snug, cut off the excess, and rotate the clasp to the underside of the pad. Use two cable ties per pad.

Step 10. Push the looped end of the cam buckle strap through the welded wire loop on the top of the Seat Post. Loop the strap and buckle back through the sewn loop to create a cinch knot as shown in **Figure 10**.

Part 4. Carrying your Basic / Comfort / Trophy System

The "System" platform comes with a small bungee to keep the Leveler Bar in place while you are transporting the stand. To use this bungee, loop it around the platform to create a cinch knot as shown in **Figure 11**. Loop it around the Leveler bar and clip it off to secure it.

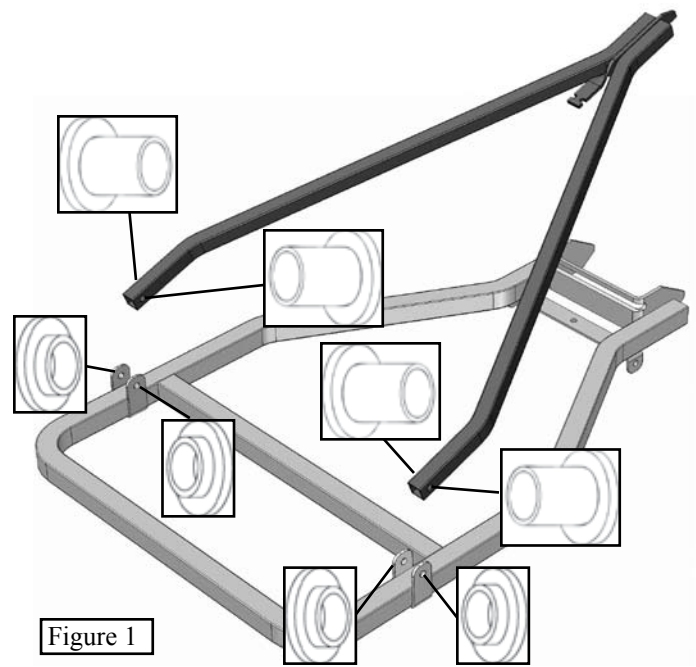

Figure 1

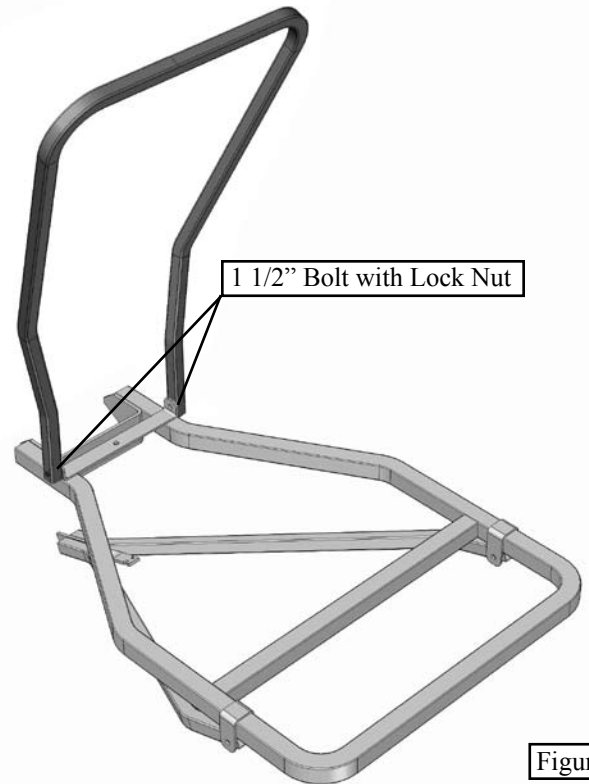

Figure 4

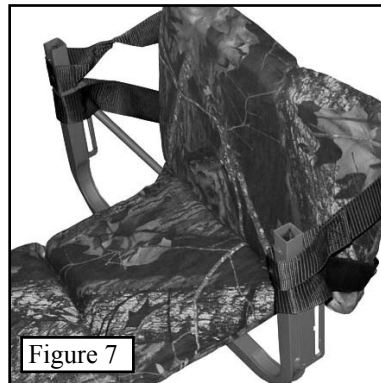

Figure 7

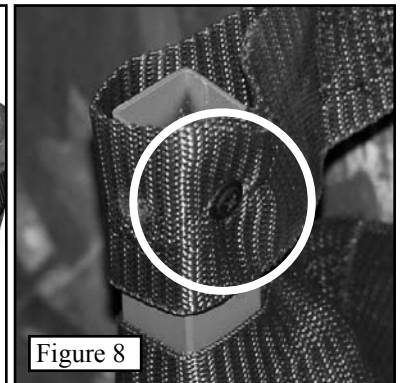

Figure 8

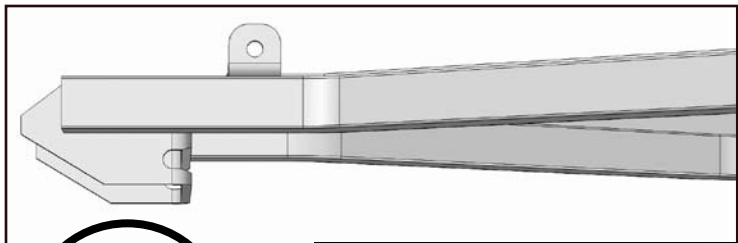
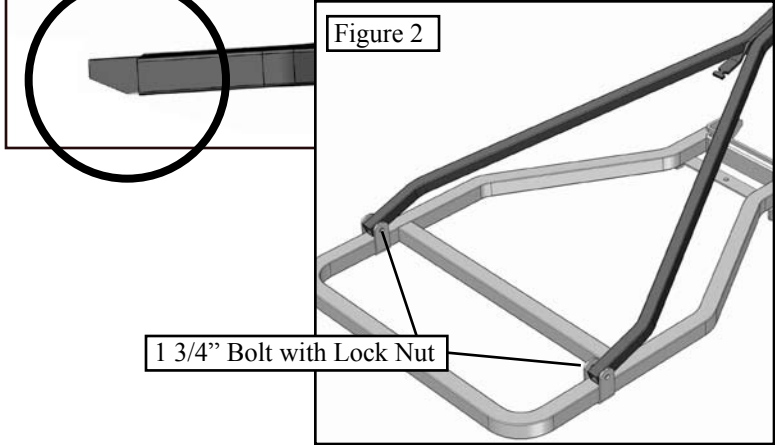

Figure 2



1 3/4" Bolt with Lock Nut

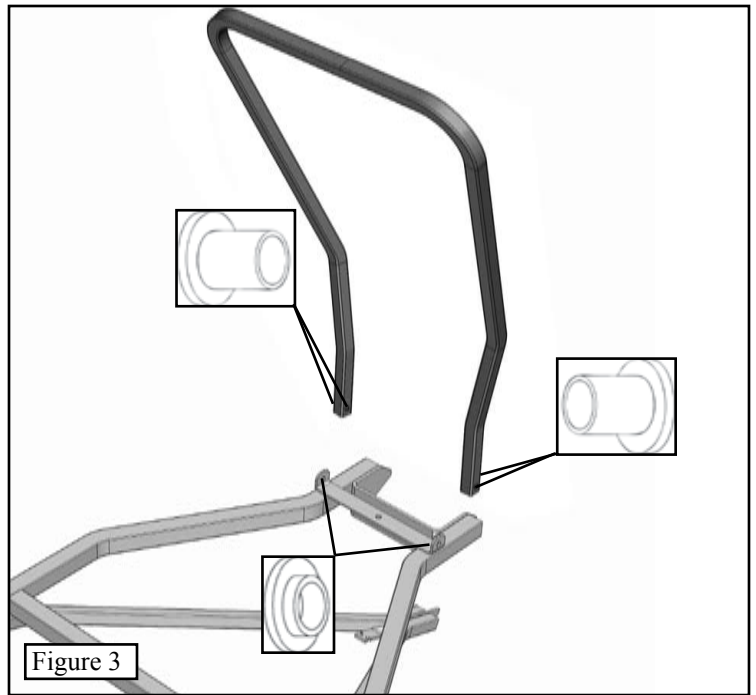
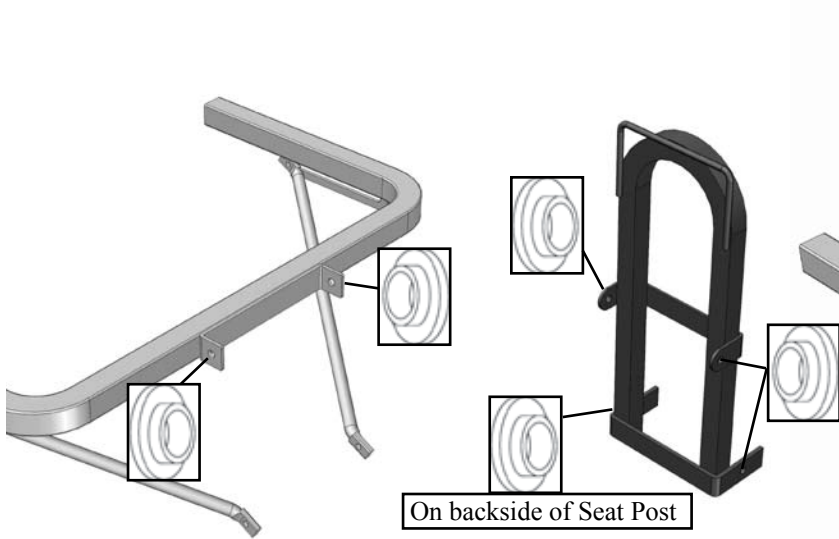
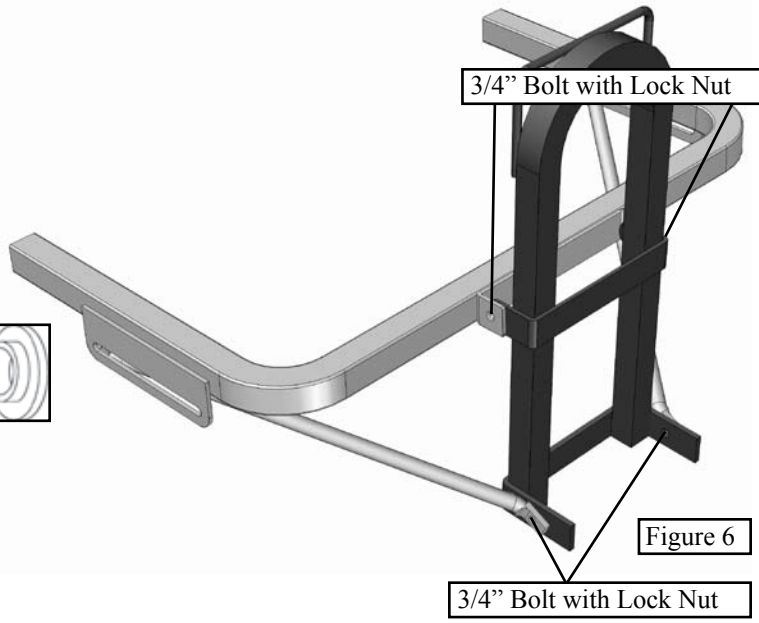

Figure 3



On backside of Seat Post

Figure 5



3/4" Bolt with Lock Nut

Figure 6

3/4" Bolt with Lock Nut



Figure 9

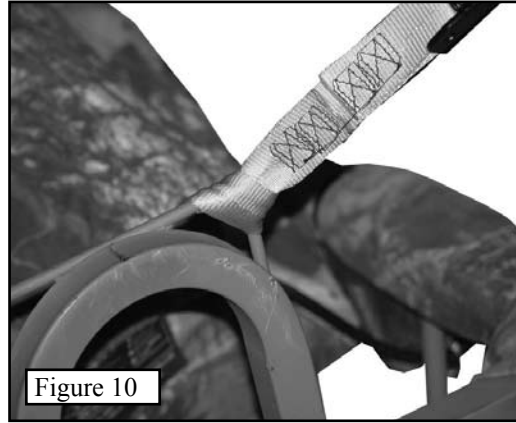

Figure 10

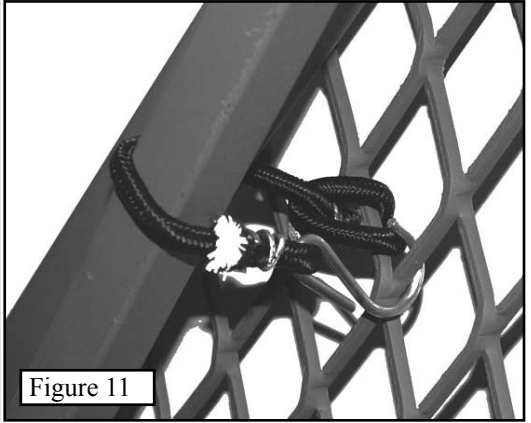

Figure 11

To carry the Trophy Chair, first fold it flat. Next, take the supplied green tourniquet buckle strap and wrap it around the frame to secure it as shown in **Figure 12**. Take the long cam buckle tree strap and bring it over your shoulder. Clip the double J-Hook into the Support Rod slide to secure as shown in **Figure 13**.

Section 2. Use of the Basic, Comfort or Trophy System.

WARNING: A LINEMAN'S STYLE HOOK UP IS MANDATORY WHEN HANGING YOUR PLATFORM OR SEAT. SEE THE HARNESS INSTRUCTIONS FOR INFORMATION ON USING THE SUPPLIED LINEMAN'S BELT!

Part 1. Attaching your Platform to the Tree.

Step 1. USING YOUR CLIMBING BELT, Climb to your desired hunting height. Wrap the ratchet strap around the tree and hook the double J-Hook into the sewn-in metal bracket as shown in **Figure 14**.

Step 2. Ratchet tight enough so that the strap does not slip down the tree but **DO NOT OVERTIGHTEN AT THIS POINT**. The strap **ONLY** needs to be tight enough so that it does not slip down the tree.

Step 3. Using a pull-up rope, haul your platform up to the ratchet strap. **WARNING: ALWAYS USE A PULL-UP ROPE!**

Step 4. Angle the platform down and hook the metal bracket over the ratchet strap bar as shown in **Figure 15**. **WARNING: MAKE SURE THE ENTIRE LENGTH OF BAR IS SECURE IN THE CHANNEL ON THE PLATFORM AS SHOWN IN FIGURE 16**.

Step 5. Rotate the front of the platform up to cam it into the tree.

Step 6. Once the platform is level, bring the V-Shaped Leveling bar up and secure it into the tree as shown in **Figure 17**.

Step 7. Attach the adjustment chain to the Leveling bar as shown in **Figure 18**. **NOTE:** This chain does not need to be tight - it is designed to limit the downward movement of the Leveling bar if it were to be come dislodged.

Step 8. Once the platform has been positioned correctly and it is level, tighten the ratchet strap. **WITH YOUR CLIMBING BELT STILL ATTACHED** - pull down on the front of the platform to seat it into the tree.

Step 9 (Comfort System Only). Fold the seat bar up and off of the platform. Position the seat so that the sitting pad is parallel with the platform as shown in **Figure 19**. Wrap the top strap around the tree and cinch it tight. Once the top strap has been secured, wrap the bottom strap around the tree and tighten. This lower strap can be let out or pulled tight to adjust seat comfort. **WARNING: MAKE SURE BOTH STRAPS ARE THREADED COMPLETELY THROUGH THE BUCKLES BEFORE SITTING (SEE FIGURE 20)**.

Step 10 (Trophy System Only). Position the Trophy Chair at the desired height off of the platform. Wrap the cam buckle strap around the tree and hook the double J-Hook into the seat frame as shown in **Figure 21**. Pull the free end of the strap until tight. Wrap the supplied green tourniquet buckle strap around the frame and the tree to secure (See **Figure 22**). Push down on the chair to seat it into the tree. Secure the seat by wrapping the bungee cord around the tree and clipping it off.

Step 11. Attach your safety rope above your platform or seat. REFER TO THE TREESTAND HARNESS INSTRUCTIONS FOR PROPER PLACEMENT AND USE. Connect your harness tether to your safety rope. Once you are properly connected, **THEN AND ONLY THEN** should you remove your lineman's hookup.

WARNING: ALWAYS STEP DOWN TO YOUR PLATFORM FROM YOUR CLIMBING STICKS OR LADDER. NEVER CLIMB UP ON TO THE PLATFORM!

NOTE: Summit recommends the use of the SOP Climbing System Accessory with all ladder and hang-on treestands. More information on this product can be found on our website - www.summitstands.com - or by calling 256-353-0634.

Part 2. Detaching From The Tree

Step 1. Once you are securely back on your ladder or climbing sticks, and once you have your lineman's belt back on - lift up on the front of the stand to unseat the Leveling bar. Remove the chain.

Step 2. Rotate the entire platform down to un-cam it from the tree. Lift up on the platform to remove it from the ratchet strap.

Step 3. Lower the platform back to the ground.

Step 4. Loosen the ratchet strap and remove it.

Section 3. Maintenance and Care of Your Treestand.

Because of the quality construction techniques used in manufacturing, your Summit Treestand is very durable under normal hunting conditions. However, since all hunting equipment that is exposed to the elements requires some maintenance and care, the following guidelines for caring for your treestand should be used. **DO NOT** leave your treestand outdoors when it is not being used. **Any tubing that is allowed to fill with rainwater and freeze WILL rupture or burst. DO NOT use your treestand if this happens.** If your treestand is exposed to the elements, it will be necessary to cover the seat to prevent rain and moisture from saturating the material. This will extend the life of the seat material as well as make it more comfortable the next time it is used.

The powder coat finish that is applied at the factory is very durable and should need touch ups only in areas of heavy wear or accidental impact.

Should you damage any part of your Summit Treestand, contact your nearest authorized Summit dealer or the factory to obtain the proper corrective action procedure and/or replacement parts for the treestand. Unauthorized repairs, modifications, or alterations will void the warranty and could degrade the integrity of the treestand. You must perform periodic inspections of the treestand for damage. **WARNING: DO NOT** use the treestand if **ANY** obvious or suspected damage is observed.

CAUTION: Look for nicks, gouges, cuts, cracks, bends, corrosion or similar damage that can be the result of improper user or accidental damage. For instance, this could occur if someone else used the treestand without knowledge of its proper use, or if the treestand were dropped, hit by a motor vehicle or subject to corrosive conditions, etc. Summit Treestands have the highest structural integrity by design, material selection and manufacturing techniques, but as its owner, only your continued care will assure trouble free performance. When the above-mentioned guidelines are followed, your Summit Treestand will provide years of successful hunting.

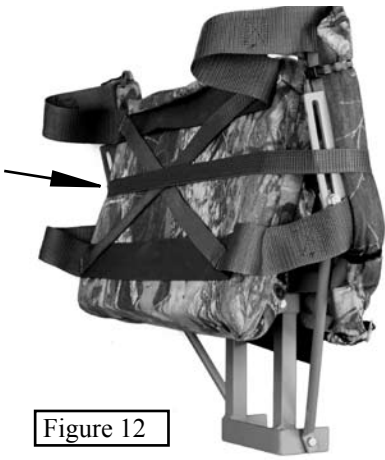

Figure 12



Figure 13

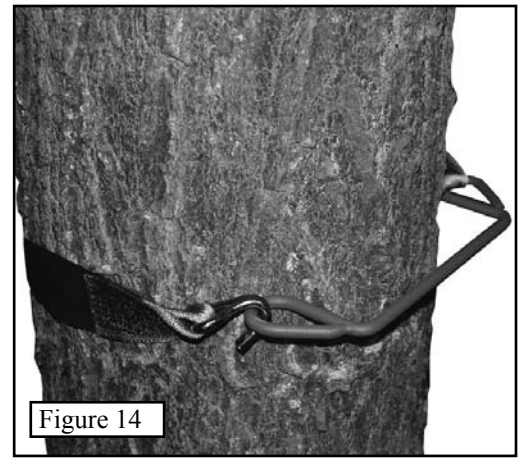

Figure 14

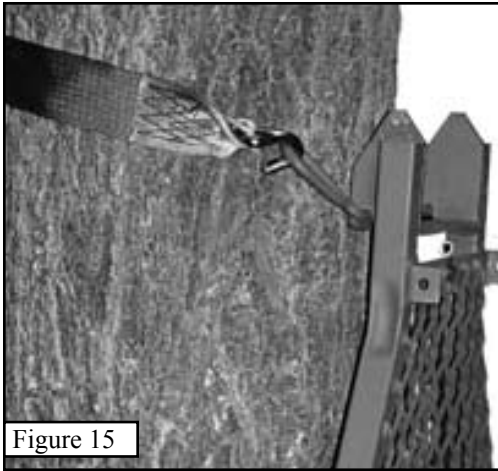

Figure 15

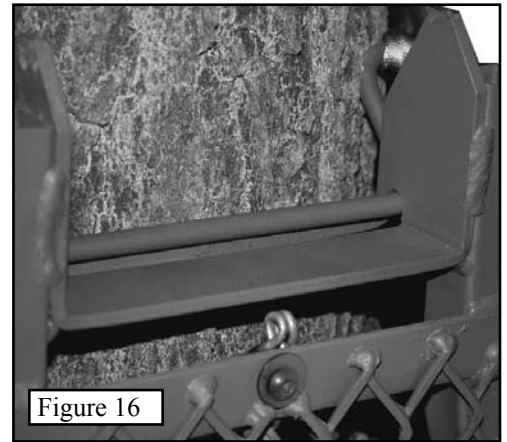

Figure 16

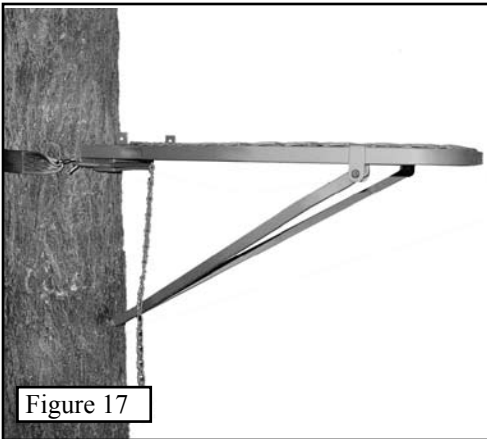

Figure 17

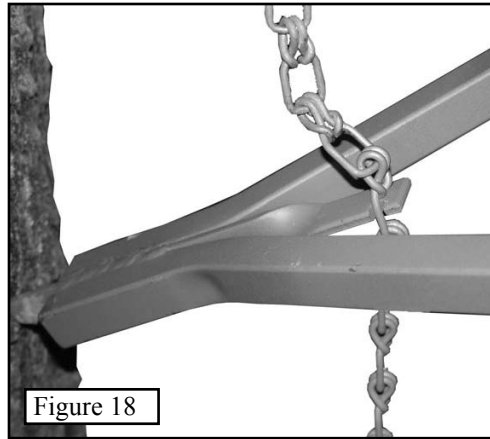

Figure 18



Figure 19

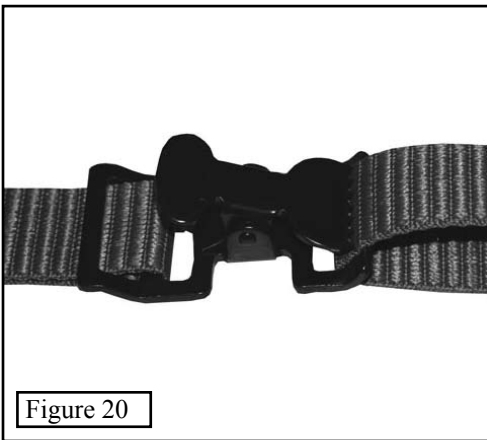

Figure 20

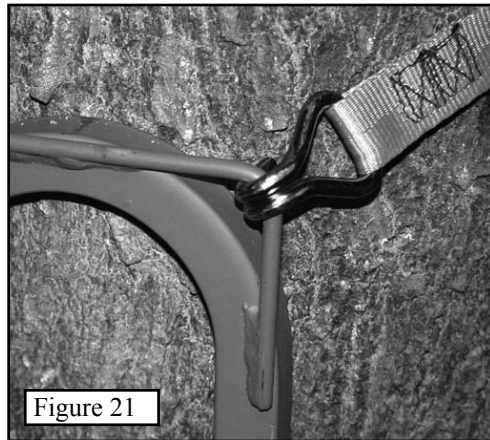

Figure 21

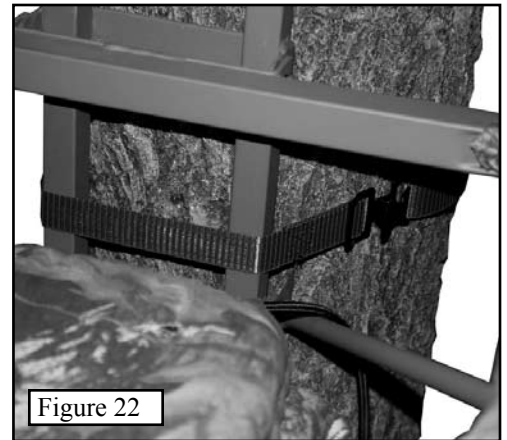

Figure 22

Tips

You will easily learn how to use your Summit treestand more efficiently and make it more effective for your hunting.

Changing your sitting position can relieve muscle stress and reduce fatigue. This will allow a longer hunt and perhaps an opportunity for a shot. Although it must be done slowly and quietly, repositioning and changing the height of your seat by raising or lowing the seat frame just a couple of inches could make a difference. This changes the hip to knee angle. Moving the seat straps, again slowly and quietly, forward or backward on their support bar will alter the sitting position also. Being comfortable will result in no movement and reduce being detected by game either from sight or from sound.

Harness Suspension

It is necessary and very important that someone knows your hunting location and time of return. It is also very important that you carry (on your person) emergency communication devices such as a cell phone, two-way radio, whistle, signal flare or preferably a PLD (Personal Locator Device - FCC approved July, '03). When triggered, a PLD will transmit an emergency signal to local rescue teams identifying your location via satellite GPS coordinates. Wilderness outfitters and the internet are sources for these PLD's.

Suspension trauma or blood pooling can occur when suspended motionless in a harness for periods of time. This can lead to unconsciousness. **WARNING: IF YOU HAVE TO HANG IN THE TREE BEFORE HELP ARRIVES, YOU NEED TO EXERCISE YOUR LEGS BY PUSHING OFF FROM THE TREE OR BY USING THE ENCLOSED SUSPENSION RELIEF STRAP. SEE THE TREESTAND HARNESS INSTRUCTIONS AND THE ENCLOSED INSTRUCTIONS FOR MORE INFORMATION.**

Self extraction may be necessary in the unfortunate situation that A) No one knows your location, B) Your communication efforts are exhausted, and C) You're confident that you have the strength, dexterity and ability to perform self-extraction and D) You decide this is your "absolute last resort". It is necessary to carry a device to assist with this self-extraction. Simple devices such as screw-in steps or a rope "Tree Descender" (available from Summit) will allow you to remove the weight from your harness. This may enable you to return to the treestand/ladder/climbing steps or slowly descend the tree.

Good Hunting and Hunt Safe!

HUNT TOMORROW...

...USE YOUR SAFETY HARNESS TODAY!

©(STLLC 2006)

Summit products are manufactured under one or more of the following US patents: 4,991,690 ; 5,226,505 ; 5,413,192 ; 5,937,969 ; 5,971,104 ; 5,975,242 ; 6,182,792 ; 5,979,603 ; 6,397,973 and Des. 417,011 ; 420,147. Summit MegaSampson, Bucksteps, Seat-O-The-Pants Safety Line and Rapid Climb Stirrups are patent pending.

Limited Warranty

(A) Warranty

Summit Treestands, LLC (Summit) warrants to the original retail purchaser that all products manufactured by it are free from defects in material and manufacture at the time of shipment for sixty (60) months from the date of purchase. Summit will repair or replace any part found defective if the unit claimed to be defective shall be returned to Summit, postage prepaid, within the warranty period.

This warranty shall not apply to any product which has been subjected to misuse; misapplication; neglect (including but not limited to improper maintenance); accident; improper installation; modification (including but not limited to use of unauthorized parts or attachments); adjustment or repair. THE FOREGOING IS IN LIEU OF ALL OTHER WARRANTIES, WHETHER EXPRESS OR IMPLIED (INCLUDING THOSE OF MERCHANTABILITY AND FITNESS OF ANY PRODUCT FOR A PARTICULAR PURPOSE), AND OF ANY OTHER OBLIGATION OF LIABILITY ON THE PART OF THE COMPANY.

(B) Limitation of Liability

It is expressly understood that Summit's liability for its products, whether due to breach of warranty, negligence, strict liability, or otherwise, is limited to the repair of the product, as stated above, and Summit will not be liable for any other injury, loss, damage, or expense, whether direct or consequential, including but not limited to loss of use, income, profit, or damage to material, arising in connection with the sale, installation, use of, inability to use, or the repair or replacement of Summit's products.

Summit reserves the right to make alterations or modifications in its products at any time, which in its opinion, may improve the performance and efficiency of the product. It shall not be obligated to make such alterations or modifications to products already in service.

Please fill out the warranty card and return to:

**SUMMIT Treestands, LLC.
715 Summit Dr.
Decatur, AL 35601**

You can also register your warranty card on line at:

www.summitstands.com/warranty.aspx

Cut Along Line

Cut Along Line

Warranty Card for Summit Treestand

Treestand Purchased: Basic System (PN 82017) Comfort System (PN 82018) Trophy System (PN 82019)

Owners Name: _____ Street Address: _____

City: _____ State: _____ ZIP: _____ Phone: (____) _____

Date Purchased: _____ Purchased From (Dealer Name): _____ Price \$: _____

Your heard about us through: Magazine Advertisement Video Friend Summit Catalog

Other Please Explain: _____

Parts List

BOX CONTENTS BASIC SYSTEM

PN	DESCRIPTION	QTY
71111	Platform (Chain Attached)	1
10926	V-Shaped Leveling Bar	1
72017	Basic System Packet	1

72017 BASIC SYSTEM ACCESSORY PACKET CONTENTS

PN	DESCRIPTION	QTY
85093	2" Ratchet Strap with Metal Bar	1
83032	Summit 4 Point Safety Harness	1
83023	Safety line with Prussic Hitch	1
10512	Locking Clip for safety line / harness	1
10953	Suspension Relief Strap with instructions	1
30331	Lineman's strap	1
30346	Short platform bungee with hook	1
10886	2006 Instructional DVD	1
	Written instructions for this stand	
	Written instructions for Summit Harness	
22017	Hardware Packet	1

22017 BASIC SYSTEM HARDWARE PACKET CONTENTS

PN	DESCRIPTION	QTY
10601	1 3/4" Bolt (1/4 -20)	2
10612	Centerlock Nut (1/4 -20)	2
10641	Short Shank Bushing	4
10640	Long Shank Bushing	4

BOX CONTENTS COMFORT SYSTEM

PN	DESCRIPTION	QTY
71111	Platform (Chain Attached)	1
10926	V-Shaped Leveling Bar	1
72018	Comfort System Packet	1
85077	Comfort System Foam Seat with Frame	1

72018 BASIC SYSTEM ACCESSORY PACKET CONTENTS

PN	DESCRIPTION	QTY
85093	2" Ratchet Strap with Metal Bar	1
83032	Summit 4 Point Safety Harness	1
83023	Safety line with Prussic Hitch	1
10512	Locking Clip for safety line / harness	1
10953	Suspension Relief Strap with instructions	1
30331	Lineman's strap	1
30346	Short platform bungee with hook	1
10886	2006 Instructional DVD	1
	Written instructions for this stand	
	Written instructions for Summit Harness	
22018	Hardware Packet	1

22018 BASIC SYSTEM HARDWARE PACKET CONTENTS

PN	DESCRIPTION	QTY
10601	1 3/4" Bolt (1/4 -20)	2
10600	1 1/2" Bolt (1/4 -20)	2
10612	Centerlock Nut (1/4 -20)	4
10641	Short Shank Bushing	6
10640	Long Shank Bushing	8

BOX CONTENTS TROPHY SYSTEM

PN	DESCRIPTION	QTY
71111	Platform (Chain Attached)	1
10926	V-Shaped Leveling Bar	1
10922	Trophy Chair Seat Post Assy	1
71121	Trophy Chair Support Assy.	1
85037	Trophy Chair Foam Seat	1
72019	Trophy System Packet	1







72019 TROPHY SYSTEM ACCESSORY PACKET CONTENTS

PN	DESCRIPTION	QTY
85093	2" Ratchet Strap with Metal Bar	1
83032	Summit 4 Point Safety Harness	1
83023	Safety line with Prussic Hitch	1
10512	Locking Clip for safety line / harness	1
10953	Suspension Relief Strap with instructions	1
30331	Lineman's strap	1
71223	12" Arm Pad	2
85051	In-Line Cable ties	4
85048	Cam buckle strap	1
30346	Short platform bungee with hook	1
10886	2006 Instructional DVD	1
	Written instructions for this stand	
	Written instructions for Summit Harness	
22019	Hardware Packet	1

22019 TROPHY SYSTEM HARDWARE PACKET CONTENTS

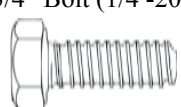
PN	DESCRIPTION	QTY
10601	1 3/4" Bolt (1/4 -20)	2
10605	3/4" Bolt (1/4 -20)	4
10612	Centerlock Nut (1/4 -20)	6
10641	Short Shank Bushing	10
10640	Long Shank Bushing	4
10628	Self Tapping Screws	2

PART QUANTITIES VARY ACCORDING TO HARDWARE PACKET CONTENTS:

PN	DESCRIPTION	PN	DESCRIPTION
10641	Short Shank Bushing	10640	Long Shank Bushing
			
10612	Centerlock Nut (1/4 -20)	10605	3/4" Bolt (1/4 -20)
			
10600	1 1/2" Bolt (1/4 -20)	10628	Self Tapping Screw
			
10601	1 3/4" Bolt (1/4 -20)		
			

Visit us on the web at
www.summitstands.com
for accessories and
upgrades!

Basic System

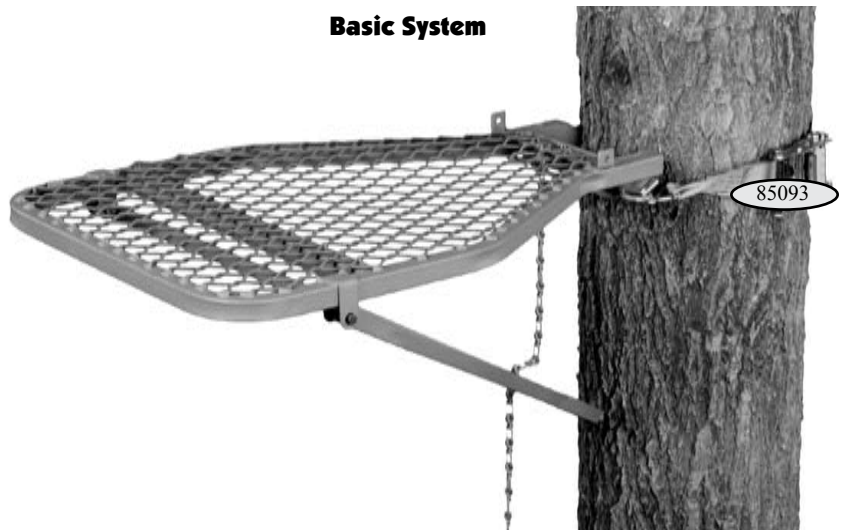

Comfort System



Trophy System

