

# CT181 Instruction Sheet

Custom Service Department  
Address: 2245 Delany Rd.  
Waukegan, IL 60087  
Phone: 847.244.1800  
800.323.4656  
Fax: 847.244.1818  
800.327.1698

## Part List:

- A. 1 - Top
- B. 2 - Legs
- C. 3 - Certwood Rail Sets
- D. 1 - Castor Pack ( 2 w/ Brake, 2 w/o Brake)
- E. 24 - M6 x 10 Flat Phillips Screws
- F. 4 - M6 x 35 Allen Head Screws

## Tools Needed:

- G. 1 - Allen Wrench (Included)
- 1 - Phillips Screw Driver

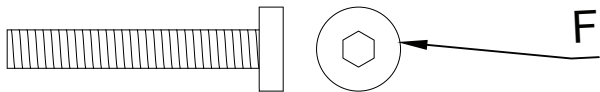
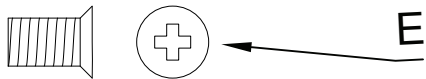
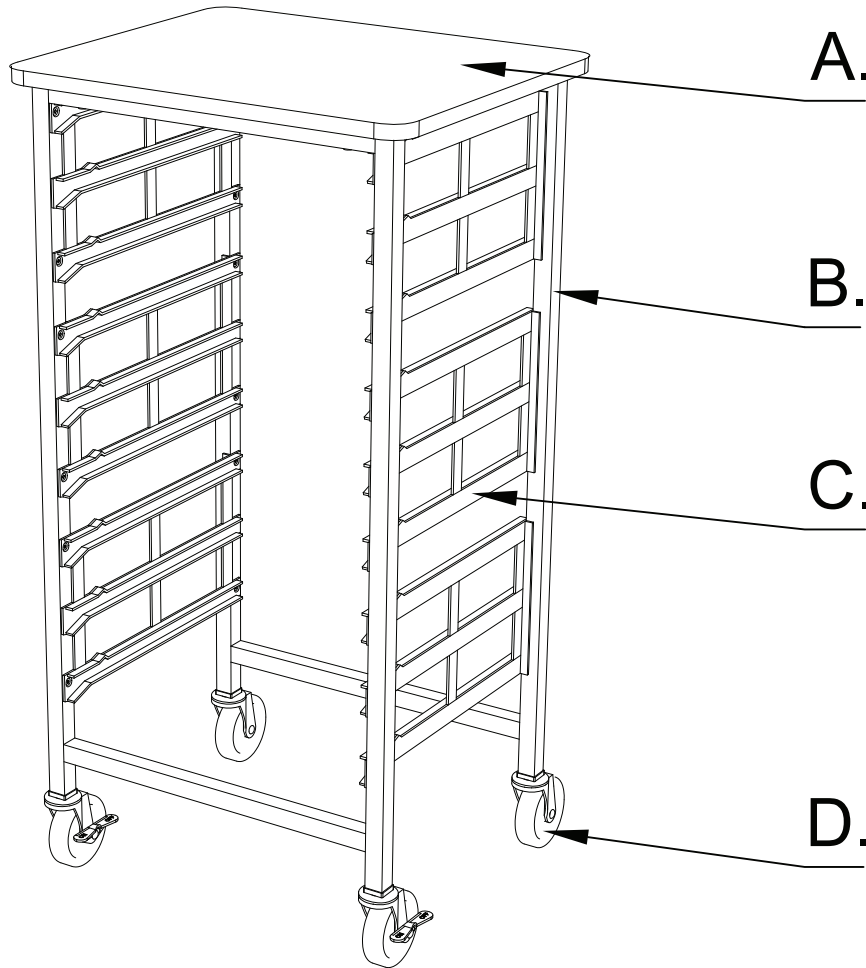

# CT181 Instruction Sheet

Custom Service Department  
Address: 2245 Delany Rd.  
Waukegan, IL 60087  
Phone: 847.244.1800  
800.323.4656  
Fax: 847.244.1818  
800.327.1698

Step 1: Screw legs to top with the M6 x 35 Allen screws.

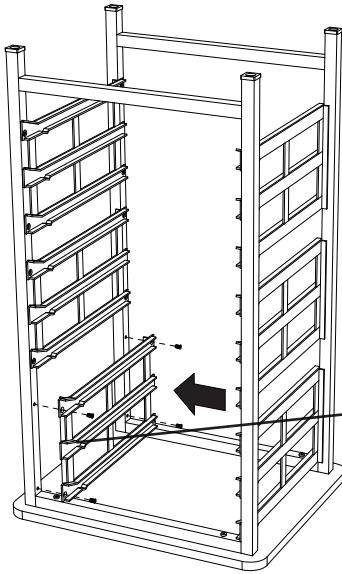
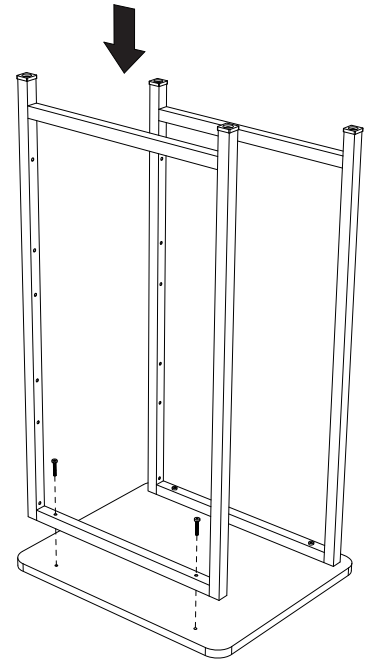

Tray catch notch faces the top.  
Rails come in a Left and Right pair.

Step 2: Screw Certwood rails to the legs with M6 x 10 Flat Phillips screws.

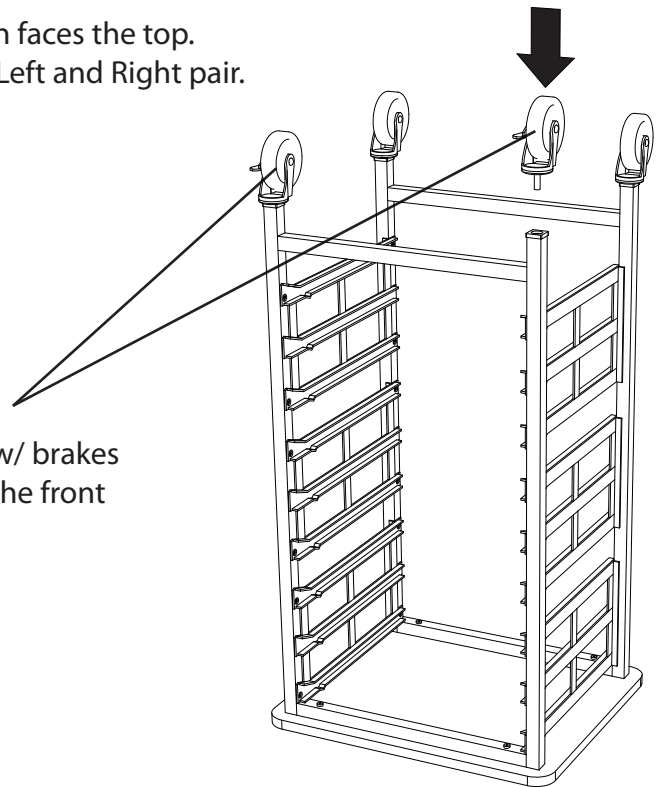

Casters w/ brakes toward the front

Step 3: Press casters into the legs.

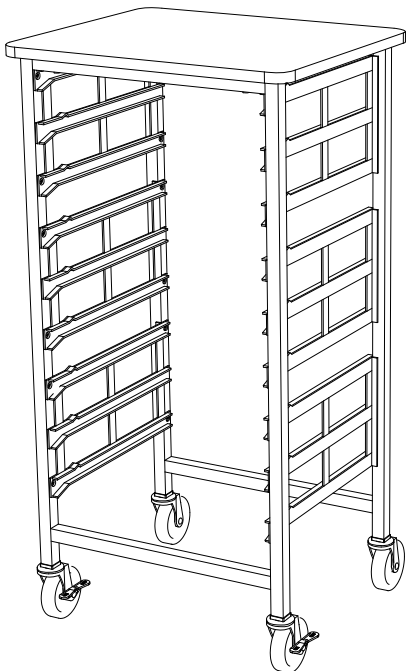

Step 4: Insert Certwood trays into rails.